



**COMMONWEALTH OF PENNSYLVANIA
DEPARTMENT OF ENVIRONMENTAL PROTECTION
AIR QUALITY PROGRAM**

STATE ONLY SYNTHETIC MINOR OPERATING PERMIT

Issue Date: December 9, 2024

Effective Date: December 9, 2024

Expiration Date: December 8, 2029

In accordance with the provisions of the Air Pollution Control Act, the Act of January 8, 1960, P.L. 2119, as amended, and 25 Pa. Code Chapter 127, the Owner, [and Operator if noted] (hereinafter referred to as permittee) identified below is authorized by the Department of Environmental Protection (Department) to operate the air emission source(s) more fully described in this permit. This Facility is subject to all terms and conditions specified in this permit. Nothing in this permit relieves the permittee from its obligations to comply with all applicable Federal, State and Local laws and regulations.

The regulatory or statutory authority for each permit condition is set forth in brackets. All terms and conditions in this permit are federally enforceable unless otherwise designated.

State Only Permit No: 41-00010

Synthetic Minor

Federal Tax Id - Plant Code: 14-1438713-1

Owner Information

Name: ANDRITZ INC
Mailing Address: 35 SHERMAN ST
MUNCY, PA 17756-1227

Plant Information

Plant: ANDRITZ INC/MUNCY FOUNDRY
Location: 41 Lycoming County 41804 Muncy Borough
SIC Code: 3559 Manufacturing - Special Industry Machinery, Nec

Responsible Official

Name: ROBERT CLUA
Title: PRESIDENT
Phone: (570) 546 - 8211 Email: Robert.Clua@Andritz.com

Permit Contact Person

Name: JOSHUA D GARDNER
Title: ENVIRONMENTAL MANAGER
Phone: (570) 546 - 1284 Email: Joshua.Gardner@Andritz.com

[Signature] _____

MUHAMMAD Q. ZAMAN, ENVIRONMENTAL PROGRAM MANAGER, NORTHCENTRAL REGION



SECTION A. Table of Contents

Section A. Facility/Source Identification

Table of Contents
Site Inventory List

Section B. General State Only Requirements

- #001 Definitions.
- #002 Operating Permit Duration.
- #003 Permit Renewal.
- #004 Operating Permit Fees under Subchapter I.
- #005 Transfer of Operating Permits.
- #006 Inspection and Entry.
- #007 Compliance Requirements.
- #008 Need to Halt or Reduce Activity Not a Defense.
- #009 Duty to Provide Information.
- #010 Revising an Operating Permit for Cause.
- #011 Operating Permit Modifications
- #012 Severability Clause.
- #013 De Minimis Emission Increases.
- #014 Operational Flexibility.
- #015 Reactivation of Sources
- #016 Health Risk-based Emission Standards and Operating Practice Requirements.
- #017 Circumvention.
- #018 Reporting Requirements.
- #019 Sampling, Testing and Monitoring Procedures.
- #020 Recordkeeping.
- #021 Property Rights.
- #022 Alternative Operating Scenarios.
- #023 Reporting
- #024 Report Format

Section C. Site Level State Only Requirements

- C-I: Restrictions
- C-II: Testing Requirements
- C-III: Monitoring Requirements
- C-IV: Recordkeeping Requirements
- C-V: Reporting Requirements
- C-VI: Work Practice Standards
- C-VII: Additional Requirements
- C-VIII: Compliance Certification
- C-IX: Compliance Schedule

Section D. Source Level State Only Requirements

- D-I: Restrictions
- D-II: Testing Requirements
- D-III: Monitoring Requirements
- D-IV: Recordkeeping Requirements
- D-V: Reporting Requirements
- D-VI: Work Practice Standards
- D-VII: Additional Requirements

Note: These same sub-sections are repeated for each source!

Section E. Source Group Restrictions

- E-I: Restrictions



SECTION A. Table of Contents

- E-II: Testing Requirements
- E-III: Monitoring Requirements
- E-IV: Recordkeeping Requirements
- E-V: Reporting Requirements
- E-VI: Work Practice Standards
- E-VII: Additional Requirements

Section F. Alternative Operating Scenario(s)

- F-I: Restrictions
- F-II: Testing Requirements
- F-III: Monitoring Requirements
- F-IV: Recordkeeping Requirements
- F-V: Reporting Requirements
- F-VI: Work Practice Standards
- F-VII: Additional Requirements

Section G. Emission Restriction Summary

Section H. Miscellaneous

**SECTION A. Site Inventory List**

Source ID	Source Name	Capacity/Throughput	Fuel/Material
039	NATURAL GAS FIRED HEATERS		
040	NATURAL GAS FIRED HEATERS >2.5MMBTU/HR		
117	SURFACE COATING SPRAY BOOTH & CURING HEATER		
118	POLYURETHANE FOAM PACKAGING OPERATION		
119	PATTERN SHOP		
120	DEGREASERS		
121	LADLE TORCHES		
138	ELECTRIC INDUCTION FURNACES		
139	REFINER PLATE MOLDING OPERATION		
142	FLOOR MOLDING (NO-BAKE) OPERATION		
144	GENERAL CASTINGS OPERATION		
145	EMERGENCY GENERATOR ENGINES		
146	ABOVEGROUND STORAGE TANKS		
P153	PLATE FINISHING OPERATIONS		
P154	R&D OPERATION		
C10	AMERICAN AIR FILTER FABRIC COLLECTOR		
C117	OVERSPRAY FILTERS		
C119	PATTERN SHOP CYCLONE		
C13	WHEELABRATOR MODEL 144 SERIES 6P FABRIC COLLECTOR		
C139	AMEREX BIN VENT COLLECTOR		
C141	JOHNSON-MARCH FABRIC COLLECTOR		
C144	AMERICAN AIR FILTER FABRIC COLLECTOR		
C15	TORIT MODEL TBV-4 BIN VENT CARTRIDGE COLLECTOR		
C154	FABRIC COLLECTOR		
C16	TORIT MODEL TBV-4 BIN VENT CARTRIDGE COLLECTOR		
FM01	NATURAL GAS LINE		
FM03	FOUR PROPANE STORAGE TANKS		
S039	NATURAL GAS HEATERS STACKS		
S040	GAS HEATER >2.5 STACKS		
S117	SURFACE COATING STACK		
S119	PATTERN SHOP CYCLONE EXHST		
S13	WHEELABRATOR FABRIC COLLECTOR STACK		
S139	AMEREX EXHAUST		
S141	JOHNSON-MARCH EXHAUST		
S144	AMERICAN AIR EXHAUST		
S145	EMERGENCY GEN. EXHAUSTS		
S15	TORIT MODEL TBV-4 BIN VENT CARTRIDGE COLLECTOR STACK		
S154	STACK		

**SECTION A. Site Inventory List**

Source ID	Source Name	Capacity/Throughput	Fuel/Material
S16	TORIT MODEL TBV-4 BIN VENT CARTRIDGE COLLECTOR STACK		
S36	AMERICAN AIR FILTER EXHAUST		
Z01	INDUCTION FURNACE EMISSIONS		
Z118	FOAM PACKAGING FUGITIVES		
Z119	PATTERN SHOP FUGITIVES		
Z120	COLD DEGRESRS'S FUGITIVES		
Z121	LADLE TORCHES' FUGITIVES		
Z139	REFINER PLATE FUGITIVES		
Z142	FLOOR MOLDING FUGITIVES		
Z146	ABOVEGRND TANK FUGITIVES		

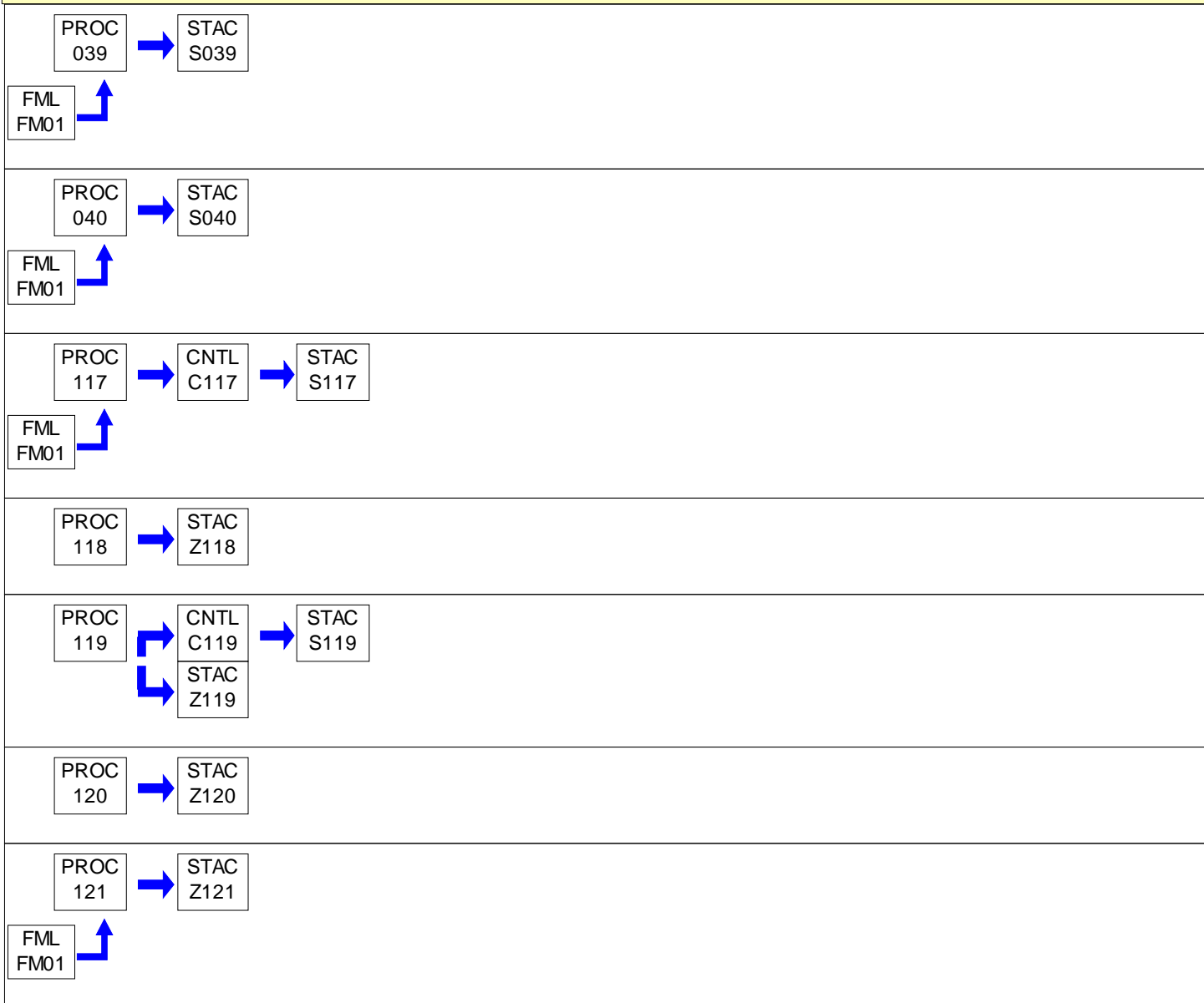
PERMIT MAPS



PERMIT MAPS

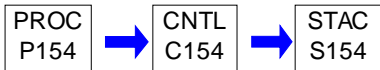
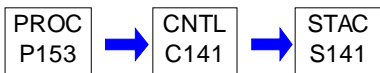
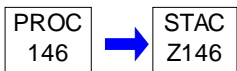
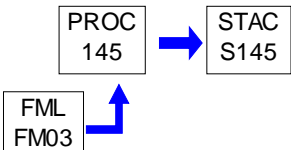
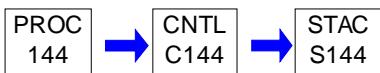
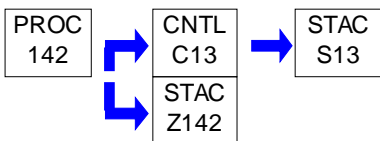
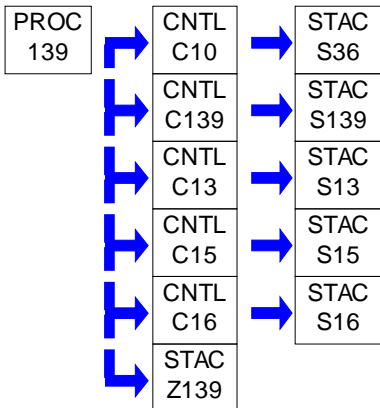
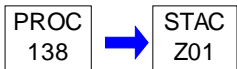

**SECTION B. General State Only Requirements****#001 [25 Pa. Code § 121.1]****Definitions.**

Words and terms that are not otherwise defined in this permit shall have the meanings set forth in Section 3 of the Air Pollution Control Act (35 P.S. § 4003) and in 25 Pa. Code § 121.1.

#002 [25 Pa. Code § 127.446]**Operating Permit Duration.**

(a) This operating permit is issued for a fixed term of five (5) years and shall expire on the date specified on Page 1 of this permit.

(b) The terms and conditions of the expired permit shall automatically continue pending issuance of a new operating permit, provided the permittee has submitted a timely and complete application and paid applicable fees required under 25 Pa. Code Chapter 127, Subchapter I and the Department is unable, through no fault of the permittee, to issue or deny a new permit before the expiration of the previous permit.

#003 [25 Pa. Code §§ 127.412, 127.413, 127.414, 127.446 & 127.703(b)]**Permit Renewal.**

(a) The permittee shall submit a timely and complete application for renewal of the operating permit to the appropriate Regional Air Program Manager. The application for renewal of the operating permit shall be submitted at least six (6) months and not more than 18 months before the expiration date of this permit.

(b) The application for permit renewal shall include the current permit number, a description of any permit revisions that occurred during the permit term, and any applicable requirements that were promulgated and not incorporated into the permit during the permit term. An application is complete if it contains sufficient information to begin processing the application, has the applicable sections completed and has been signed by a responsible official.

(c) The permittee shall submit with the renewal application a fee for the processing of the application as specified in 25 Pa. Code § 127.703(b). The fees shall be made payable to "The Commonwealth of Pennsylvania Clean Air Fund" and submitted with the fee form to the respective regional office.

(d) The renewal application shall also include submission of proof that the local municipality and county, in which the facility is located, have been notified in accordance with 25 Pa. Code § 127.413.

(e) The application for renewal of the operating permit shall also include submission of supplemental compliance review forms in accordance with the requirements of 25 Pa. Code § 127.412(b) and § 127.412(j).

(f) The permittee, upon becoming aware that any relevant facts were omitted or incorrect information was submitted in the permit application, shall promptly submit such supplementary facts or corrected information as necessary to address any requirements that become applicable to the source after the permittee submits a complete application, but prior to the date the Department takes action on the permit application.

#004 [25 Pa. Code § 127.703]**Operating Permit Fees under Subchapter I.**

(a) The permittee shall pay the annual operating permit maintenance fee according to the following fee schedule in either paragraph (1) or (2) in accordance with 25 Pa. Code § 127.703(d) on or before December 31 of each year for the next calendar year.

(1) For a synthetic minor facility, a fee equal to:

(i) Four thousand dollars (\$4,000) for calendar years 2021—2025.

(ii) Five thousand dollars (\$5,000) for calendar years 2026—2030.

(iii) Six thousand three hundred dollars (\$6,300) for the calendar years beginning with 2031.

**SECTION B. General State Only Requirements**

(2) For a facility that is not a synthetic minor, a fee equal to:

- (i) Two thousand dollars (\$2,000) for calendar years 2021—2025.
- (ii) Two thousand five hundred dollars (\$2,500) for calendar years 2026—2030.
- (iii) Three thousand one hundred dollars (\$3,100) for the calendar years beginning with 2031.

(b) The applicable fees shall be made payable to "The Commonwealth of Pennsylvania Clean Air Fund" with the permit number clearly indicated and submitted to the respective regional office.

#005 [25 Pa. Code §§ 127.450 (a)(4) and 127.464]**Transfer of Operating Permits.**

(a) This operating permit may not be transferred to another person, except in cases of transfer-of-ownership that are documented and approved by the Department.

(b) In accordance with 25 Pa. Code § 127.450(a)(4), a change in ownership of the source shall be treated as an administrative amendment if the Department determines that no other change in the permit is required and a written agreement has been submitted to the Department identifying the specific date of the transfer of permit responsibility, coverage and liability between the current and the new permittee and a compliance review form has been submitted to, and the permit transfer has been approved by, the Department.

(c) This operating permit is valid only for those specific sources and the specific source locations described in this permit.

#006 [25 Pa. Code § 127.441 and 35 P.S. § 4008]**Inspection and Entry.**

(a) Upon presentation of credentials and other documents as may be required by law, the permittee shall allow the Department or authorized representatives of the Department to perform the following:

(1) Enter at reasonable times upon the permittee's premises where a source is located or emissions related activity is conducted, or where records are kept under the conditions of this permit;

(2) Have access to and copy, at reasonable times, any records that are kept under the conditions of this permit;

(3) Inspect at reasonable times, any facilities, equipment including monitoring and air pollution control equipment, practices, or operations regulated or required under this permit;

(4) Sample or monitor, at reasonable times, any substances or parameters, for the purpose of assuring compliance with the permit or applicable requirements as authorized by the Clean Air Act, the Air Pollution Control Act, or the regulations promulgated under the Acts.

(b) Pursuant to 35 P.S. § 4008, no person shall hinder, obstruct, prevent or interfere with the Department or its personnel in the performance of any duty authorized under the Air Pollution Control Act or regulations adopted thereunder including denying the Department access to a source at this facility. Refusal of entry or access may constitute grounds for permit revocation and assessment of criminal and/or civil penalties.

(c) Nothing in this permit condition shall limit the ability of the EPA to inspect or enter the premises of the permittee in accordance with Section 114 or other applicable provisions of the Clean Air Act.

#007 [25 Pa. Code §§ 127.441 & 127.444]**Compliance Requirements.**

(a) The permittee shall comply with the conditions of this operating permit. Noncompliance with this permit constitutes a violation of the Clean Air Act and the Air Pollution Control Act and is grounds for one or more of the following:

**SECTION B. General State Only Requirements**

- (1) Enforcement action
- (2) Permit termination, revocation and reissuance or modification
- (3) Denial of a permit renewal application

(b) A person may not cause or permit the operation of a source which is subject to 25 Pa. Code Article III unless the source(s) and air cleaning devices identified in the application for the plan approval and operating permit and the plan approval issued for the source is operated and maintained in accordance with specifications in the applications and the conditions in the plan approval and operating permit issued by the Department. A person may not cause or permit the operation of an air contamination source subject to 25 Pa. Code Chapter 127 in a manner inconsistent with good operating practices.

(c) For purposes of Sub-condition (b) of this permit condition, the specifications in applications for plan approvals and operating permits are the physical configurations and engineering design details which the Department determines are essential for the permittee's compliance with the applicable requirements in this State-Only permit. Nothing in this sub-condition shall be construed to create an independent affirmative duty upon the permittee to obtain a predetermination from the Department for physical configuration or engineering design detail changes made by the permittee.

#008 [25 Pa. Code § 127.441]**Need to Halt or Reduce Activity Not a Defense.**

It shall not be a defense for the permittee in an enforcement action that it was necessary to halt or reduce the permitted activity in order to maintain compliance with the conditions of this permit.

#009 [25 Pa. Code §§ 127.442(a) & 127.461]**Duty to Provide Information.**

(a) The permittee shall submit reports to the Department containing information the Department may prescribe relative to the operation and maintenance of each source at the facility.

(b) The permittee shall furnish to the Department, in writing, information that the Department may request to determine whether cause exists for modifying, revoking and reissuing, or terminating this permit, or to determine compliance with the permit. Upon request, the permittee shall also furnish to the Department copies of records that the permittee is required to maintain in accordance with this permit.

#010 [25 Pa. Code § 127.461]**Revising an Operating Permit for Cause.**

This operating permit may be terminated, modified, suspended or revoked and reissued if one or more of the following applies:

- (1) The permittee constructs or operates the source subject to the operating permit so that it is in violation of the Air Pollution Control Act, the Clean Air Act, the regulations thereunder, a plan approval, a permit or in a manner that causes air pollution.
- (2) The permittee fails to properly or adequately maintain or repair an air pollution control device or equipment attached to or otherwise made a part of the source.
- (3) The permittee has failed to submit a report required by the operating permit or an applicable regulation.
- (4) The EPA determines that the permit is not in compliance with the Clean Air Act or the regulations thereunder.

#011 [25 Pa. Code §§ 127.450, 127.462, 127.465 & 127.703]**Operating Permit Modifications**

(a) The permittee is authorized to make administrative amendments, minor operating permit modifications and significant operating permit modifications, under this permit, as outlined below:

**SECTION B. General State Only Requirements**

(b) Administrative Amendments. The permittee shall submit the application for administrative operating permit amendments (as defined in 25 Pa. Code § 127.450(a)), according to procedures specified in § 127.450 unless precluded by the Clean Air Act or its regulations.

(c) Minor Operating Permit Modifications. The permittee shall submit the application for minor operating permit modifications (as defined 25 Pa. Code § 121.1) in accordance with 25 Pa. Code § 127.462.

(d) Significant Operating Permit Modifications. The permittee shall submit the application for significant operating permit modifications in accordance with 25 Pa. Code § 127.465.

(e) The applicable fees shall be made payable to "The Commonwealth of Pennsylvania Clean Air Fund" with the permit number clearly indicated and submitted to the respective regional office.

#012 [25 Pa. Code § 127.441]**Severability Clause.**

The provisions of this permit are severable, and if any provision of this permit is determined by a court of competent jurisdiction to be invalid or unenforceable, such a determination will not affect the remaining provisions of this permit.

#013 [25 Pa. Code § 127.449]**De Minimis Emission Increases.**

(a) This permit authorizes de minimis emission increases in accordance with 25 Pa. Code § 127.449 so long as the permittee provides the Department with seven (7) days prior written notice before commencing any de minimis emissions increase. The written notice shall:

(1) Identify and describe the pollutants that will be emitted as a result of the de minimis emissions increase.

(2) Provide emission rates expressed in tons per year and in terms necessary to establish compliance consistent with any applicable requirement.

(b) The Department may disapprove or condition de minimis emission increases at any time.

(c) Except as provided below in (d), the permittee is authorized to make de minimis emission increases (expressed in tons per year) up to the following amounts without the need for a plan approval or prior issuance of a permit modification:

(1) Four tons of carbon monoxide from a single source during the term of the permit and 20 tons of carbon monoxide at the facility during the term of the permit.

(2) One ton of NO_x from a single source during the term of the permit and 5 tons of NO_x at the facility during the term of the permit.

(3) One and six-tenths tons of the oxides of sulfur from a single source during the term of the permit and 8.0 tons of oxides of sulfur at the facility during the term of the permit.

(4) Six-tenths of a ton of PM₁₀ from a single source during the term of the permit and 3.0 tons of PM₁₀ at the facility during the term of the permit. This shall include emissions of a pollutant regulated under Section 112 of the Clean Air Act unless precluded by the Clean Air Act, the regulations thereunder or 25 Pa. Code Article III.

(5) One ton of VOCs from a single source during the term of the permit and 5.0 tons of VOCs at the facility during the term of the permit. This shall include emissions of a pollutant regulated under Section 112 of the Clean Air Act unless precluded by the Clean Air Act, the regulations thereunder or 25 Pa. Code Article III.

(6) Other sources and classes of sources determined to be of minor significance by the Department.

(d) In accordance with § 127.14, the permittee is authorized to install the following minor sources without the need for a plan approval or permit modification:

**SECTION B. General State Only Requirements**

(1) Air conditioning or ventilation systems not designed to remove pollutants generated or released from other sources.

(2) Combustion units rated at 2,500,000 or less Btu per hour of heat input.

(3) Combustion units with a rated capacity of less than 10,000,000 Btu per hour heat input fueled by natural gas supplied by a public utility or by commercial fuel oils which are No. 2 or lighter, viscosity less than or equal to 5.82 c St, and which meet the sulfur content requirements of 25 Pa. Code §123.22 (relating to combustion units). For purposes of this permit, commercial fuel oil shall be virgin oil which has no reprocessed, recycled or waste material added.

(4) Space heaters which heat by direct heat transfer.

(5) Laboratory equipment used exclusively for chemical or physical analysis.

(6) Other sources and classes of sources determined to be of minor significance by the Department.

(e) This permit does not authorize de minimis emission increases if the emissions increase would cause one or more of the following:

(1) Increase the emissions of a pollutant regulated under Section 112 of the Clean Air Act except as authorized in Subparagraphs (c)(4) and (5) of this permit condition.

(2) Subject the facility to the prevention of significant deterioration requirements in 25 Pa. Code Chapter 127, Subchapter D and/or the new source review requirements in Subchapter E.

(3) Violate any applicable requirement of this permit, the Air Pollution Control Act, the Clean Air Act, or the regulations promulgated under either of the acts.

(f) Emissions authorized under this permit condition shall be included in the monitoring, recordkeeping and reporting requirements of this permit.

(g) Except for de minimis emission increases, installation of minor sources made pursuant to this permit condition and Plan Approval Exemptions under 25 Pa. Code § 127.14 (relating to exemptions), the permittee is prohibited from making changes or engaging in activities that are not specifically authorized under this permit without first applying for a plan approval. In accordance with § 127.14(b), a plan approval is not required for the construction, modification, reactivation, or installation of the sources creating the de minimis emissions increase.

(h) The permittee may not meet de minimis emission threshold levels by offsetting emission increases or decreases at the same source.

#014 [25 Pa. Code § 127.3]**Operational Flexibility.**

The permittee is authorized to make changes within the facility in accordance with the regulatory provisions outlined in 25 Pa. Code § 127.3 (relating to operational flexibility) to implement the operational flexibility requirements provisions authorized under Section 6.1(i) of the Air Pollution Control Act and the operational flexibility terms and conditions of this permit. The provisions in 25 Pa. Code Chapter 127 which implement the operational flexibility requirements include the following:

(1) Section 127.14 (relating to exemptions)

(2) Section 127.447 (relating to alternative operating scenarios)

(3) Section 127.448 (relating to emissions trading at facilities with Federally enforceable emissions caps)

(4) Section 127.449 (relating to de minimis emission increases)

(5) Section 127.450 (relating to administrative operating permit amendments)

**SECTION B. General State Only Requirements**

(6) Section 127.462 (relating to minor operating permit modifications)

(7) Subchapter H (relating to general plan approvals and general operating permits)

#015 [25 Pa. Code § 127.11a]**Reactivation of Sources**

(a) The permittee may not reactivate a source that has been out of operation or production for at least one year unless the reactivation is conducted in accordance with a plan approval granted by the Department or in accordance with reactivation and maintenance plans developed and approved by the Department in accordance with 25 Pa. Code § 127.11a(a).

(b) A source which has been out of operation or production for more than five (5) years but less than 10 years may be reactivated and will not be considered a new source if the permittee satisfies the conditions specified in 25 Pa. Code § 127.11a(b).

#016 [25 Pa. Code § 127.36]**Health Risk-based Emission Standards and Operating Practice Requirements.**

(a) When needed to protect public health, welfare and the environment from emissions of hazardous air pollutants from new and existing sources, the permittee shall comply with the health risk-based emission standards or operating practice requirements imposed by the Department, except as precluded by §§ 6.6(d)(2) and (3) of the Air Pollution Control Act [35 P.S. § 4006.6(d)(2) and (3)].

(b) A person challenging a performance or emission standard established by the Department has the burden to demonstrate that performance or emission standard does not meet the requirements of Section 112 of the Clean Air Act.

#017 [25 Pa. Code § 121.9]**Circumvention.**

No person may permit the use of a device, stack height which exceeds good engineering practice stack height, dispersion technique or other technique which, without resulting in reduction of the total amount of air contaminants emitted, conceals or dilutes an emission of air contaminants which would otherwise be in violation of 25 Pa. Code Article III, except that with prior approval of the Department, the device or technique may be used for control of malodors.

#018 [25 Pa. Code §§ 127.402(d) & 127.442]**Reporting Requirements.**

(a) The permittee shall comply with the applicable reporting requirements of the Clean Air Act, the regulations thereunder, the Air Pollution Control Act and 25 Pa. Code Article III including Chapters 127, 135 and 139.

(b) The permittee shall submit reports to the Department containing information the Department may prescribe relative to the operation and maintenance of any air contamination source.

(c) Reports, test data, monitoring data, notifications and requests for renewal of the permit shall be submitted to the:

Regional Air Program Manager
PA Department of Environmental Protection
(At the address given in the permit transmittal letter, or otherwise notified)

(d) Any records or information including applications, forms, or reports submitted pursuant to this permit condition shall contain a certification by a responsible official as to truth, accuracy and completeness. The certifications submitted under this permit shall require a responsible official of the facility to certify that based on information and belief formed after reasonable inquiry, the statements and information in the documents are true, accurate and complete.

(e) Any records, reports or information submitted to the Department shall be available to the public except for such

**SECTION B. General State Only Requirements**

records, reports or information which meet the confidentiality requirements of § 4013.2 of the Air Pollution Control Act and §§ 112(d) and 114(c) of the Clean Air Act. The permittee may not request a claim of confidentiality for any emissions data generated for the facility.

#019 [25 Pa. Code §§ 127.441(c) & 135.5]**Sampling, Testing and Monitoring Procedures.**

(a) The permittee shall comply with the monitoring, recordkeeping or reporting requirements of 25 Pa. Code Chapter 139 and the other applicable requirements of 25 Pa. Code Article III and additional requirements related to monitoring, reporting and recordkeeping required by the Clean Air Act and the regulations thereunder including the Compliance Assurance Monitoring requirements of 40 CFR Part 64, where applicable.

(b) Unless alternative methodology is required by the Clean Air Act and regulations adopted thereunder, sampling, testing and monitoring required by or used by the permittee to demonstrate compliance with any applicable regulation or permit condition shall be conducted in accordance with the requirements of 25 Pa. Code Chapter 139.

#020 [25 Pa. Code §§ 127.441(c) and 135.5]**Recordkeeping.**

(a) The permittee shall maintain and make available, upon request by the Department, the following records of monitored information:

- (1) The date, place (as defined in the permit) and time of sampling or measurements.
- (2) The dates the analyses were performed.
- (3) The company or entity that performed the analyses.
- (4) The analytical techniques or methods used.
- (5) The results of the analyses.
- (6) The operating conditions as existing at the time of sampling or measurement.

(b) The permittee shall retain records of any required monitoring data and supporting information for at least five (5) years from the date of the monitoring, sample, measurement, report or application. Supporting information includes the calibration data and maintenance records and original strip-chart recordings for continuous monitoring instrumentation, and copies of reports required by the permit.

(c) The permittee shall maintain and make available to the Department upon request, records including computerized records that may be necessary to comply with the reporting, recordkeeping and emission statement requirements in 25 Pa. Code Chapter 135 (relating to reporting of sources). In accordance with 25 Pa. Code Chapter 135, § 135.5, such records may include records of production, fuel usage, maintenance of production or pollution control equipment or other information determined by the Department to be necessary for identification and quantification of potential and actual air contaminant emissions.

#021 [25 Pa. Code § 127.441(a)]**Property Rights.**

This permit does not convey any property rights of any sort, or any exclusive privileges.

#022 [25 Pa. Code § 127.447]**Alternative Operating Scenarios.**

The permittee is authorized to make changes at the facility to implement alternative operating scenarios identified in this permit in accordance with 25 Pa. Code § 127.447.

**SECTION B. General State Only Requirements****#023 [25 Pa. Code §135.3]****Reporting**

(a) If the facility is a Synthetic Minor Facility, the permittee shall submit by March 1 of each year an annual emissions report for the preceding calendar year. The report shall include information for all active previously reported sources, new sources which were first operated during the preceding calendar year, and sources modified during the same period which were not previously reported. All air emissions from the facility should be estimated and reported.

(b) A source owner or operator of a Synthetic Minor Facility may request an extension of time from the Department for the filing of an annual emissions report, and the Department may grant the extension for reasonable cause.

#024 [25 Pa. Code §135.4]**Report Format**

If applicable, the emissions reports shall contain sufficient information to enable the Department to complete its emission inventory. Emissions reports shall be made by the source owner or operator in a format specified by the Department.

**SECTION C. Site Level Requirements****I. RESTRICTIONS.****Emission Restriction(s).****# 001 [25 Pa. Code §123.1]****Prohibition of certain fugitive emissions**

The permittee shall not permit the emission of fugitive air contaminants into the outdoor atmosphere from a source other than the following:

- (1) Construction or demolition of buildings or structures.
- (2) Grading, paving and maintenance of roads and streets.
- (3) Use of roads and streets. Emissions from material in or on trucks, railroad cars and other vehicular equipment are not considered as emissions from use of roads and streets.
- (4) Clearing of land.
- (5) Stockpiling of materials.
- (6) Open burning operations.
- (7) Blasting in open pit mines. Emissions from drilling are not considered emissions from blasting.
- (8) Sources and classes of sources other than those identified above, for which the permittee has obtained a determination from the Department that fugitive emissions from the source, after appropriate control, meet the following requirements:
 - (a) The emissions are of minor significance with respect to causing air pollution.
 - (b) The emissions are not preventing or interfering with the attainment or maintenance of any ambient air quality standard.

002 [25 Pa. Code §123.2]**Fugitive particulate matter**

The permittee shall not permit fugitive particulate matter to be emitted into the outdoor atmosphere from a source specified in (1) through (8) in condition #001 herein, if the emissions are visible at the point the emissions pass outside the permittee's property.

003 [25 Pa. Code §123.41]**Limitations**

The permittee shall not permit the emission of visible air contaminants into the outdoor atmosphere in such a manner that the opacity of the emission is either of the following:

- (1) Equal to or greater than 20% for a period or periods aggregating more than three minutes in any 1 hour.
- (2) Equal to or greater than 60% at any time.

004 [25 Pa. Code §123.42]**Exceptions**

The emission limitations of 25 Pa. Code Section 123.41 shall not apply when:

- (1) The presence of uncombined water is the only reason for failure of the emission to meet the limitations;
- (2) The emission results from the operation of equipment used solely to train and test persons in observing the opacity of visible emissions;
- (3) The emission results from sources specified in (1) through (8) in condition #001 herein.

005 [25 Pa. Code §127.441]**Operating permit terms and conditions.**

The total combined emission of volatile organic compounds from all sources at this facility shall not exceed 49.00 tons in any 12 consecutive month period.

006 [25 Pa. Code §127.441]**Operating permit terms and conditions.**

[Additional authority for this permit condition is derived from the permittee volunteering to accept it as a restriction]

- (1) The total combined emission of any single hazardous air pollutant from all sources at the facility shall not equal or exceed 10 tons in any 12 consecutive month period.
- (2) The total combined emission of all hazardous air pollutants from all sources at the facility shall not equal or exceed 25 tons in any 12 consecutive month period.

**SECTION C. Site Level Requirements****# 007 [25 Pa. Code §127.441]****Operating permit terms and conditions.**

The total combined volatile organic compound emissions from Sources 039, 040, 117, 118, 119, 120, 121, 2,400 lb induction furnace, 138, 145 and 146, as well as the volatile organic compound emissions from the use of parting agents in Sources 139 and 142, shall not exceed 8.35 tons in any 12 consecutive month period.

Compliance with this permit condition also ensures compliance with the previous volatile organic compound emission limitation established pursuant to 25 Pa. Code Sections 129.91 through 129.95.

008 [25 Pa. Code §127.441]**Operating permit terms and conditions.**

The total combined emission of particulate matter, including PM-10 (particulate matter with an aerodynamic diameter of 10 microns or less), from all sources at this facility shall not exceed 99.00 tons in any 12 consecutive month period.

Throughput Restriction(s).**# 009 [25 Pa. Code §127.441]****Operating permit terms and conditions.**

The total combined metal melt production at this facility shall not exceed 14,000 tons in any 12 consecutive month period.

Compliance with this permit condition ensures the facility remains classified as a "small foundry" in accordance with 40 CFR Section 63.10880.

010 [25 Pa. Code §127.441]**Operating permit terms and conditions.**

[Additional authority for this permit condition is derived from the permittee volunteering to accept it as a restriction]

Scrap processed at this facility shall not contain motor vehicle scrap.

Compliance with this permit condition also ensures compliance with the management practices for mercury switches provisions specified in 40 CFR 63.10885, as required pursuant to 40 CFR 63.10890.

II. TESTING REQUIREMENTS.**# 011 [25 Pa. Code §139.1]****Sampling facilities.**

Upon the request of the Department, the permittee shall provide adequate sampling ports, safe sampling platforms and adequate utilities for the performance by the Department of tests on a source. The Department will set forth, in the request, the time period in which the facilities shall be provided as well as the specifications for such facilities.

012 [25 Pa. Code §139.11]**General requirements.**

(1) As specified in 25 Pa. Code Section 139.11(1), performance tests shall be conducted while the source is operating at maximum routine operating conditions or under such other conditions, within the capacity of the equipment, as may be requested by the Department.

(2) As specified in 25 Pa. Code Section 139.11(2), the Department will consider test results for approval where sufficient information is provided to verify the source conditions existing at the time of the test and where adequate data is available to show the manner in which the test was conducted. Information submitted to the Department shall include, as a minimum, all of the following:

- (a) A thorough source description, including a description of any air cleaning devices and the flue.
- (b) Process conditions, for example, the charging rate of raw material or rate of production of final product, boiler pressure, oven temperature and other conditions which may effect emissions from the process.
- (c) The location of sampling ports.
- (d) Effluent characteristics, including velocity, temperature, moisture content, gas density (percentage of CO, CO₂, O₂ and N₂), static and barometric pressures.
- (e) Sample collection techniques employed, including procedures used, equipment descriptions and data to verify that isokinetic sampling for particulate matter collection occurred and that acceptable test conditions were met.

**SECTION C. Site Level Requirements**

- (f) Laboratory procedures and results.
 (g) Calculated results.

III. MONITORING REQUIREMENTS.**# 013 [25 Pa. Code §123.43]****Measuring techniques**

Visible emissions may be measured using either of the following:

- (1) A device approved by the Department and maintained to provide accurate opacity measurements.
- (2) Observers, trained and qualified, to measure plume opacity with the naked eye or with the aid of any devices approved by the Department.

014 [25 Pa. Code §127.441]**Operating permit terms and conditions.**

The permittee shall conduct a weekly inspection of the facility during daylight hours while the facility is operating to detect:

- (1) the presence of visible air contaminant emissions.
- (2) the presence of visible fugitive air contaminant emissions.
- (3) the presence of malodorous air contaminant emission beyond the facility's property boundaries.

All detected visible air contaminant emissions, visible fugitive air contaminant emissions or malodorous air contaminant emissions that have the potential to exceed applicable limits shall be reported to the manager of the facility.

IV. RECORDKEEPING REQUIREMENTS.**# 015 [25 Pa. Code §127.441]****Operating permit terms and conditions.**

The permittee shall maintain a logbook of the weekly inspections performed at this facility and shall record all occurrences of observed visible air contaminant emissions, visible fugitive air contaminant emissions and malodorous air contaminant emissions, the name of the company representative observing these occurrences and the date and time of each such occurrence. The permittee shall also record the corrective action(s) taken to abate each recorded deviation or to prevent future occurrences. All records generated pursuant to this condition shall be retained for a minimum of five (5) years and shall be made available to the Department upon request.

016 [25 Pa. Code §127.441]**Operating permit terms and conditions.**

The permittee shall keep accurate comprehensive records of the identity and quantity of each individual hazardous air pollutant emitted from each source at the facility each month, as well as records of all supporting calculations and all assumptions made in performing any such calculations. All records generated pursuant to this condition shall be retained for at least five (5) years and shall be made available to the Department upon request.

017 [25 Pa. Code §127.441]**Operating permit terms and conditions.**

The permittee shall maintain accurate and comprehensive records on a monthly basis of the supporting calculations used to verify compliance with the volatile organic compound emission limitation specified herein for the facility and the total combined volatile organic compound emission limitation specified herein for Sources 039, 040, 117, 118, 119, 120, 121, 2,400 lb induction furnace, 138, 139 (parting agents only), 142 (parting agents only), 145 and 146. All records generated pursuant to this condition shall be retained for a minimum of five (5) years and shall be made available to the Department upon request.

018 [25 Pa. Code §135.5]**Recordkeeping**

The permittee shall maintain such records including computerized records as may be necessary to comply with 25 Pa. Code Sections 135.3 and 135.21. These may include records of production, fuel usage, maintenance of production or pollution control equipment or other information determined by the Department to be necessary for identification and quantification of potential and actual air contaminant emissions. All records generated pursuant to this condition shall be retained for a minimum of five (5) years and shall be made available to the Department upon request.

**SECTION C. Site Level Requirements****# 019 [40 CFR Part 63 NESHAPS for Source Categories §40 CFR 63.10885]****Subpart ZZZZZ - National Emission Standards for Hazardous Air Pollutants for Iron and Steel Foundries Area Sources
What are my management practices for metallic scrap and mercury switches?**

[Additional authority for this permit condition is also derived from 40 CFR 63.10890]

The permittee shall maintain a copy of the material specifications for each segregated metallic scrap storage area, bin or pile at the facility which demonstrates compliance with the requirements for restricted metallic scrap and/or the use of general scrap specified in condition #030 herein. The material specifications shall be kept on site and be readily available to all personnel with material acquisition duties, and a copy shall be provided to each scrap provider. All records generated pursuant to this condition shall be retained for a minimum of five (5) years and shall be made available to the Department upon request.

020 [40 CFR Part 63 NESHAPS for Source Categories §40 CFR 63.10885]**Subpart ZZZZZ - National Emission Standards for Hazardous Air Pollutants for Iron and Steel Foundries Area Sources
What are my management practices for metallic scrap and mercury switches?**

[Additional authority for this permit condition is also derived from 40 CFR 63.10890]

The permittee shall maintain records which document that scrap purchased for use at this facility does not contain motor vehicle scrap. All records generated pursuant to this condition shall be retained for a minimum of five (5) years and shall be made available to the Department upon request.

021 [40 CFR Part 63 NESHAPS for Source Categories §40 CFR 63.10890]**Subpart ZZZZZ - National Emission Standards for Hazardous Air Pollutants for Iron and Steel Foundries Area Sources
What are my management practices and compliance requirements?**

The permittee shall maintain accurate and comprehensive records of the total combined facility-wide metal melt production for each calendar year. All records generated pursuant to this condition shall be retained for a minimum of five (5) years and shall be made available to the Department upon request.

022 [40 CFR Part 63 NESHAPS for Source Categories §40 CFR 63.10890]**Subpart ZZZZZ - National Emission Standards for Hazardous Air Pollutants for Iron and Steel Foundries Area Sources
What are my management practices and compliance requirements?**

The permittee shall maintain accurate and comprehensive records of the annual quantity and composition of each hazardous air pollutant-containing chemical binder or coating material used to make molds and cores. These records must be copies of purchasing records, Material Safety Data Sheets, or other documentation that provides information on the binder or coating materials used. All records generated pursuant to this condition shall be retained for a minimum of five (5) years and shall be made available to the Department upon request.

V. REPORTING REQUIREMENTS.**# 023 [25 Pa. Code §127.441]****Operating permit terms and conditions.**

The permittee shall submit all requested reports in accordance with the Department's suggested format.

024 [25 Pa. Code §127.441]**Operating permit terms and conditions.**

The permittee shall submit to the Department on a semi-annual basis a report which identifies the amount of each individual hazardous pollutant emitted from each source at the facility each month for the previous 12 months. The reports shall also include a copy of all supporting calculations and assumptions made in performing any such calculations. The semi-annual reports shall be submitted to the Department no later than March 1 (for the immediately-preceding January 1 through December 31 period) and September 1 (for the immediately-preceding July 1 through June 30 period).

025 [25 Pa. Code §127.441]**Operating permit terms and conditions.**

The submission of all requests, reports, application submittals and other communications required by Subpart ZZZZZ of the National Emissions Standards for Hazardous Air Pollutants, 40 CFR Sections 63.10880 through 63.10906, or required by any other applicable section specified in the National Emission Standards for Hazardous Air Pollutants, must be made to both the Department of Environmental Protection and electronically to the Environmental Protection Agency. The electronic reports must be submitted using the subpart specific reporting form in the Compliance and Emissions Data

**SECTION C. Site Level Requirements**

Reporting Interface (CEDRI) that is accessed through EPA's Central Data Exchange (CDX) (www.epa.gov/cdx). However, if the reporting form specific to this subpart is not available in CEDRI at the time that the report is due, the written report must be submitted to the Administrator's postal address listed below.

Associate Director
EPA Region 3, Air and Radiation Division,
Permits Branch (3AD10)
Four Penn Center, 1600 John F. Kennedy Boulevard,
Philadelphia, Pennsylvania 19103-2852

Department of Environmental Protection copies may be sent to:

Pennsylvania Department of Environmental Protection
Air Quality Program Manager
208 W. Third Street, Suite 101
Williamsport, PA 17701

026 [25 Pa. Code §127.441]**Operating permit terms and conditions.**

The permittee shall submit semi-annual reports to the Department of the supporting calculations used to verify compliance with the volatile organic compound emission limitation specified herein for the facility and the total combined volatile organic compound emission limitation specified herein for Sources 039, 040, 117, 118, 119, 120, 121, 2,400 lb induction furnace, 138, 139 (parting agents only), 142 (parting agents only), 145 and 146. The semi-annual reports shall be submitted to the Department no later than September 1 (for the immediately preceding July 1 through June 30 period) and March 1 (for the immediately-preceding January 1 through December 31 period) for the previous 12 consecutive month period.

027 [25 Pa. Code §127.442]**Reporting requirements.**

(a) The permittee shall report malfunctions, emergencies or incidents of excess emissions to the Department. A malfunction is any sudden, infrequent, and not reasonably preventable failure of air pollution control equipment, process equipment, or a process to operate in a normal or usual manner. An emergency is any situation arising from sudden and reasonably unforeseeable events beyond the control of the owner or operator of a facility which requires immediate corrective action to restore normal operation and which causes the emission source to exceed emissions, due to unavoidable increases in emissions attributable to the situation. An emergency shall not include situations caused by improperly designed equipment, lack of preventive maintenance, careless or improper operation, or operator error.

(b) When the malfunction, emergency or incident of excess emissions poses an imminent danger to the public health, safety, welfare, or environment, it shall be reported to the Department and the County Emergency Management Agency by telephone within one (1) hour after the discovery of the malfunction, emergency or incident of excess emissions. The owner or operator shall submit a written or emailed report of instances of such malfunctions, emergencies or incidents of excess emissions to the Department within three (3) business days of the telephone report.

(c) The report shall describe the following:

1. name, permit or authorization number, and location of the facility,
2. nature and cause of the malfunction, emergency or incident,
3. date and time when the malfunction, emergency or incident was first observed,
4. expected duration of excess emissions,
5. estimated rate of emissions,
6. corrective actions or preventative measures taken.

(d) Any malfunction, emergency or incident of excess emissions that is not subject to the notice requirements of paragraph (b) of this condition shall be reported to the Department by telephone within 24 hours (or by 4:00 PM of the next business day, whichever is later) of discovery and in writing or by e-mail within five (5) business days of discovery. The report shall contain the same information required by paragraph (c), and any permit specific malfunction reporting requirements.

**SECTION C. Site Level Requirements**

(e) During an emergency an owner or operator may continue to operate the source at their discretion provided they submit justification for continued operation of a source during the emergency and follow all the notification and reporting requirements in accordance with paragraphs (b)-(d), as applicable, including any permit specific malfunction reporting requirements.

(f) Reports regarding malfunctions, emergencies or incidents of excess emissions shall be submitted to the appropriate DEP Regional Office Air Program Manager.

(g) Any emissions resulted from malfunction or emergency are to be reported in the annual emissions inventory report, if the annual emissions inventory report is required by permit or authorization.

028 [25 Pa. Code §135.3]**Reporting**

(1) A person who owns or operates a source to which 25 Pa. Code Chapter 135 applies, and who has previously been advised by the Department to submit an annual Air Information Management System (AIMS) report, shall submit by March 1 of each year an annual AIMS report for the preceding calendar year. The report shall include information for all previously reported sources, new sources which were first operated during the preceding calendar year and sources modified during the same period which were not previously reported.

(2) A person who receives initial notification by the Department that an annual AIMS report is necessary, shall submit an initial annual AIMS report within sixty (60) days after receiving the notification or by March 1 of the year following the year for which the report is required, whichever is later.

(3) A source owner or operator may request an extension of time from the Department for the filing of an annual AIMS report, and the Department may grant the extension for reasonable cause.

029 [40 CFR Part 63 NESHAPS for Source Categories §40 CFR 63.10890]**Subpart ZZZZ - National Emission Standards for Hazardous Air Pollutants for Iron and Steel Foundries Area Sources
What are my management practices and compliance requirements?**

The permittee shall submit semi-annual compliance reports to the Department which clearly identifies any deviation from the scrap restriction identified in condition #010 herein or the pollution prevention management practices identified in condition #031 herein and the corrective action taken. The semi-annual reports shall be submitted to the Department no later than September 1 (for the immediately-preceding July 1 through June 30 period) and March 1 (for the immediately-preceding January 1 through December 31 period) for the previous 12 consecutive month period.

VI. WORK PRACTICE REQUIREMENTS.**# 030 [25 Pa. Code §123.1]****Prohibition of certain fugitive emissions**

The permittee shall take all reasonable actions to prevent particulate matter from becoming airborne from any source specified in (1) through (8) in condition #001 herein. These actions shall include, but not be limited to, the following:

(1) Use, where possible, of water or chemicals for control of dust in the demolition of buildings or structures, construction operations, the grading of roads or the clearing of land.

(2) Application of asphalt, oil, or suitable chemicals on dirt roads, material stockpiles and other surfaces which may give rise to airborne dusts.

(3) Paving and maintenance of roadways.

(4) Prompt removal of earth or other material from paved streets onto which earth or other material has been transported by trucking or earth moving equipment, erosion by water, or other means.

031 [40 CFR Part 63 NESHAPS for Source Categories §40 CFR 63.10885]**Subpart ZZZZ - National Emission Standards for Hazardous Air Pollutants for Iron and Steel Foundries Area Sources
What are my management practices for metallic scrap and mercury switches?**

[Additional authority for this permit condition is also derived from 40 CFR 63.10890]

The permittee shall comply with the metallic scrap management practices specified herein.

For each segregated metallic scrap storage area, bin or pile, the permittee shall comply with the materials acquisition requirements in paragraph (1) or (2) of this condition. The permittee may have certain scrap subject to paragraph (1) of this

**SECTION C. Site Level Requirements**

condition and other scrap subject to paragraph (2) of this condition at the facility provided the metallic scrap remains segregated until charge makeup.

(1) Restricted metallic scrap. The permittee shall prepare and operate at all times according to written material specifications for the purchase and use of only metal ingots, pig iron, slitter, or other materials that do not include post-consumer automotive body scrap, post-consumer engine blocks, post-consumer oil filters, oily turnings, lead components, chlorinated plastics, or free liquids. For the purpose of this subpart, "free liquids" is defined as material that fails the paint filter test by EPA Method 9095B, "Paint Filter Liquids Test" (revision 2), November 2004 (incorporated by reference - see 40 CFR Section 63.14). The requirements for no free liquids do not apply if the permittee can demonstrate that the free liquid is water that resulted from scrap exposure to rain.

(2) General iron and steel scrap. The permittee shall prepare and operate at all times according to written material specifications for the purchase and use of only iron and steel scrap that has been depleted (to the extent practicable) of organics and hazardous air pollutant metals in the charge materials used by the permittee. The materials specifications for metallic scrap materials charged to a scrap preheater or metal melting furnace to be depleted (to the extent practicable) of the presence of used oil filters, chlorinated plastic parts, accessible lead-containing components (such as batteries and wheel weights), and a program to ensure the scrap materials are drained of free liquids.

VII. ADDITIONAL REQUIREMENTS.**# 032 [25 Pa. Code §121.7]****Prohibition of air pollution.**

The permittee shall not permit air pollution as that term is defined in the Pennsylvania Air Pollution Control Act (35 P.S. Sections 4001 through 4015).

033 [25 Pa. Code §123.31]**Limitations**

The permittee shall not permit the emission of any malodorous air contaminants into the outdoor atmosphere from any source in such a manner that the malodors are detectable outside the property of the permittee on whose land the source is being operated.

034 [25 Pa. Code §127.441]**Operating permit terms and conditions.**

Pennsylvania DEP is now accepting permit and authorization applications, as well as other documents and correspondence, electronically through DEP's Public Submission Page in Greenport. Access the web page below to submit documents: <https://greenport.pa.gov/ePermitPublicAccess/PublicSubmission/Home>.

Documents currently submitted through other electronic means such as stack test reports, emission inventory, continuous emission monitoring reports, and asbestos notifications should continue to be submitted using the previously established systems.

035 [25 Pa. Code §129.14]**Open burning operations**

The permittee shall not permit the open burning of material at this facility unless in accordance with 25 Pa. Code Section 129.14.

036 [40 CFR Part 63 NESHAPS for Source Categories §40 CFR 63.10880]**Subpart ZZZZ - National Emission Standards for Hazardous Air Pollutants for Iron and Steel Foundries Area Sources Am I subject to this subpart?**

The permittee's foundry is subject to Subpart ZZZZ of the National Emissions Standards for Hazardous Air Pollutants, 40 CFR 63.10880 through 63.10906. The permittee shall comply with all applicable requirements specified in Subpart ZZZZ, as well as any other applicable requirements specified in the National Emission Standards for Hazardous Air Pollutants.

VIII. COMPLIANCE CERTIFICATION.

No additional compliance certifications exist except as provided in other sections of this permit including Section B (relating to State Only General Requirements).

IX. COMPLIANCE SCHEDULE.



SECTION C. Site Level Requirements

No compliance milestones exist.

**SECTION D. Source Level Requirements**

Source ID: 039

Source Name: NATURAL GAS FIRED HEATERS

Source Capacity/Throughput:

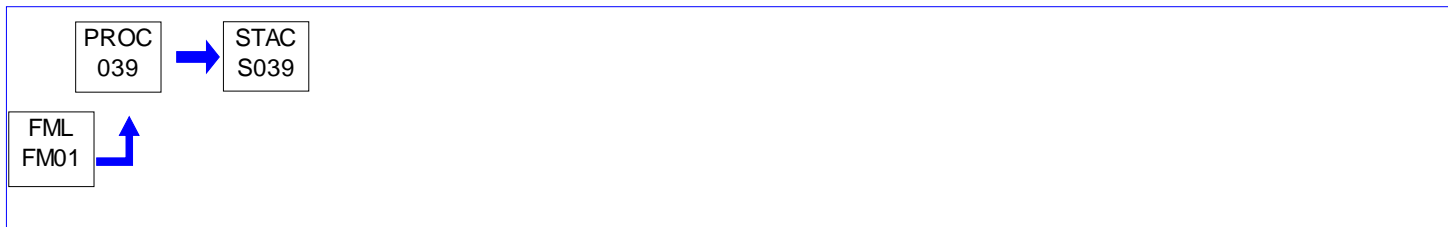
**I. RESTRICTIONS.****Emission Restriction(s).****# 001 [25 Pa. Code §123.13]****Processes**

The permittee shall not permit the emission of filterable particulate matter into the outdoor atmosphere from the natural gas-fired heaters and air makeup units incorporated in Source 039 in such a manner that the concentration in the effluent gas from the heaters and air makeup units exceed 0.04 grains per dry standard cubic foot of effluent gas volume.

002 [25 Pa. Code §123.21]**General**

The permittee shall not permit the emission of sulfur oxides, expressed as SO₂, into the outdoor atmosphere from the natural gas-fired heaters and air makeup units incorporated in Source 039 in a manner such that the concentration of the sulfur oxides in the effluent gas exceeds 500 parts per million, by volume, dry basis.

Fuel Restriction(s).**# 003 [25 Pa. Code §127.441]****Operating permit terms and conditions.**

The heaters and air makeup units incorporated in Source 039 shall be fired only on natural gas.

II. TESTING REQUIREMENTS.

No additional testing requirements exist except as provided in other sections of this permit including Section B (State Only General Requirements).

III. MONITORING REQUIREMENTS.

No additional monitoring requirements exist except as provided in other sections of this permit including Section B (State Only General Requirements).

IV. RECORDKEEPING REQUIREMENTS.

No additional record keeping requirements exist except as provided in other sections of this permit including Section B (State Only General Requirements).

V. REPORTING REQUIREMENTS.

No additional reporting requirements exist except as provided in other sections of this permit including Section B (State Only General Requirements).

**SECTION D. Source Level Requirements****VI. WORK PRACTICE REQUIREMENTS.**

No additional work practice requirements exist except as provided in other sections of this permit including Section B (State Only General Requirements).

VII. ADDITIONAL REQUIREMENTS.

004 [25 Pa. Code §127.441]

Operating permit terms and conditions.

Source 039 incorporates the following natural gas-fired heaters and air makeup units:

- (1) one 0.06 million Btu per hour York heater, located in office.
- (2) one 0.40 million Btu per hour Modine heater, located in maintenance shop.
- (3) two 0.30 million Btu per hour (each) Lennox heaters, located in pattern shop (42/42A).
- (4) two 0.25 million Btu per hour (each) Reznor heaters, located in pattern shop (40).
- (5) one 0.20 million Btu per hour (each) Reznor heaters, located in pattern shop (40A).
- (6) one 0.90 million Btu per hour Dayton heater, located in bathroom (40A).
- (7) two 0.15 million Btu per hour (each) Modine heaters, located in maintenance shop (63/78).
- (8) two 0.12 million Btu per hour (each) ReverberRay heaters, located in Building 70
- (9) one 0.075 million Btu per hour ReverberRay heater, located in Building 70
- (10) one 0.25 million Btu per hour Rheem water heater, located in foundry.
- (11) one 0.12 million Btu per hour York heater, located in foundry breakroom.
- (12) two 0.12 million Btu per hour (each) Enerco heaters, located in foundry pattern shop.
- (13) one 0.18 million Btu per hour Rheem heater, located in cast/clean (26A).
- (14) one 0.15 million Btu per hour Reznor heater, located in cast/clean (26A).
- (15) one 0.075 million Btu per hour Rheem heater, located in cast/clean shower room (26A).
- (16) one 0.12 million Btu per hour Trane heater, located in office.
- (17) one 0.25 million Btu per hour Reznor heater, located in maintenance storage (65).
- (18) one 0.25 million Btu per hour Reznor heater, located in boiler house (65).
- (19) one 0.15 million Btu per hour Reznor heater, located in maintenance storage (65).
- (20) two 0.15 million Btu per hour (each) Modine heaters, located in maintenance shop (63/78).
- (21) twenty-one 0.40 million Btu per hour (each) Modine heaters, located in FB plant.
- (22) thirteen 0.40 million Btu per hour (each) Modine heaters, located in PGS plant.
- (23) one 0.20 million Btu per hour Reznor heater, located in FB plant.
- (24) one 0.075 million Btu per hour Modine heater, located in FB plant.
- (25) one 0.20 million Btu per hour Reznor heater, located in PGS plant.
- (26) one 0.299 million Btu per hour Weil McClain heater, located in FB office.
- (27) one 0.06 million Btu per hour Trane heater, located in FB office.
- (28) two 0.06 million Btu per hour (each) Trane heaters, located in office.
- (29) one 0.20 million Btu per hour Modine heater, located in boiler room.
- (30) one 0.03 million Btu per hour Reznor heater, located in boiler room.
- (31) one 0.03 million Btu per hour Dayton heater, located in grind shop.
- (32) one 0.175 million Btu per hour heater (make unknown), located in evaporator room.
- (33) two 0.30 million Btu per hour (each) Modine heaters, located in warehouse.
- (34) one 2.4 million Btu per hour AbsoluteAire air makeup unit, located in Building 26.
- (35) one 2.0 million Btu per hour Aerovent air makeup unit, located in Building 42.
- (36) one 2.2 million Btu per hour Jackson-Church air makeup unit, located in Building 89.
- (37) one 2.5 million Btu per hour Hartzel air makeup units, located in Building 89.
- (38) two 2.50 million Btu per hour (each) Rupp air makeup units, located in Building 89.
- (39) one 2.371 million Btu per hour Cambridge air makeup units, located in Building 89.

**SECTION D. Source Level Requirements**

Source ID: 040

Source Name: NATURAL GAS FIRED HEATERS >2.5MMBTU/HR

Source Capacity/Throughput:

**I. RESTRICTIONS.****Emission Restriction(s).**

001 [25 Pa. Code §123.13]

Processes

The permittee shall not permit the emission of filterable particulate matter into the outdoor atmosphere from the natural gas-fired air makeup units incorporated in Source 040 in such a manner that the concentration in the effluent gas from the units exceed 0.04 grains per dry standard cubic foot of effluent gas volume.

002 [25 Pa. Code §123.21]

General

The permittee shall not permit the emission of sulfur oxides, expressed as SO₂, into the outdoor atmosphere from the natural gas-fired air makeup units incorporated in Source 040 in a manner such that the concentration of the sulfur oxides in the effluent gas exceeds 500 parts per million, by volume, dry basis.

Fuel Restriction(s).

003 [25 Pa. Code §127.441]

Operating permit terms and conditions.

The air makeup units incorporated in Source 040 shall be fired only on natural gas.

II. TESTING REQUIREMENTS.

No additional testing requirements exist except as provided in other sections of this permit including Section B (State Only General Requirements).

III. MONITORING REQUIREMENTS.

No additional monitoring requirements exist except as provided in other sections of this permit including Section B (State Only General Requirements).

IV. RECORDKEEPING REQUIREMENTS.

No additional record keeping requirements exist except as provided in other sections of this permit including Section B (State Only General Requirements).

V. REPORTING REQUIREMENTS.

No additional reporting requirements exist except as provided in other sections of this permit including Section B (State Only General Requirements).

**SECTION D. Source Level Requirements****VI. WORK PRACTICE REQUIREMENTS.**

No additional work practice requirements exist except as provided in other sections of this permit including Section B (State Only General Requirements).

VII. ADDITIONAL REQUIREMENTS.

004 [25 Pa. Code §127.441]

Operating permit terms and conditions.

Source 040 incorporates the following natural gas-fired air makeup units:

- (1) one 2.512 million Btu per hour Cambridge air makeup units, located in Building 89.
- (2) four 3.46 million Btu per hour (each) Powr-Matic air makeup units, located in Building 89.
- (3) one 3.812 million Btu per hour Greenheck air makeup units, located in Building 96.

**SECTION D. Source Level Requirements**

Source ID: 117

Source Name: SURFACE COATING SPRAY BOOTH & CURING HEATER

Source Capacity/Throughput:

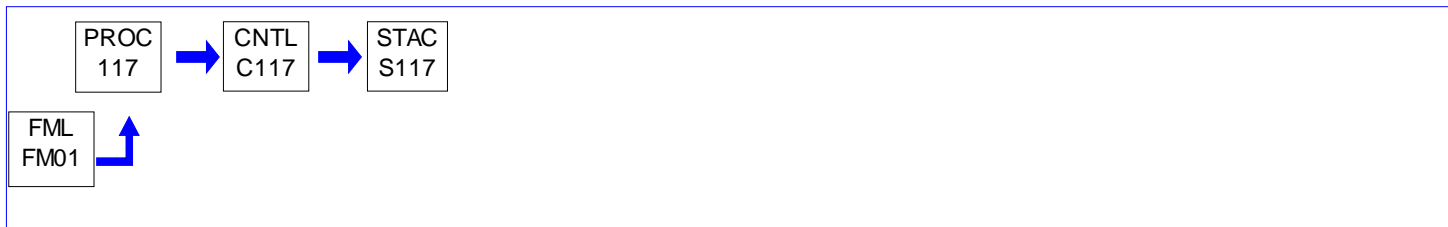
**I. RESTRICTIONS.****Emission Restriction(s).****# 001 [25 Pa. Code §123.21]****General**

The permittee shall not permit the emission of sulfur oxides, expressed as SO₂, into the outdoor atmosphere from the natural gas-fired curing heater incorporated in Source 117 in a manner such that the concentration of the sulfur oxides in the effluent gas exceeds 500 parts per million, by volume, dry basis.

002 [25 Pa. Code §127.441]**Operating permit terms and conditions.**

The permittee shall not permit the emission of filterable particulate matter into the outdoor atmosphere from Source 117 in such a manner that the concentration in the effluent gas from Control Device C117 exceeds 0.01 grains per dry standard cubic foot of effluent gas volume.

[Compliance with this condition also ensures compliance with 25 Pa. Code Section 127.13]

003 [25 Pa. Code §127.441]**Operating permit terms and conditions.**

The total combined volatile organic compound emissions resulting from the application of surface coatings and the use of cleanup solvents in Source 117 shall not exceed 2.58 tons in any 12 consecutive month period and the total combined volatile hazardous air pollutant emissions resulting from the application of surface coatings and the use of cleanup solvents in Source 117 shall not exceed 0.93 tons in any 12 consecutive month period.

004 [25 Pa. Code §129.52]**Surface coating processes**

The permittee shall not cause or permit the emission of volatile organic compounds into the outdoor atmosphere from Source 117 unless the volatile organic compound content of the as applied coating is equal to or less than 6.67 pounds of volatile organic compounds per gallon of coating solids.

The volatile organic compound content of the as applied coating, expressed in units of weight of volatile organic compounds per volume of coating solids, shall be calculated as follows:

$$\text{VOC} = (\text{Wo})(\text{Dc})/\text{Vn}$$

Where:

VOC = volatile organic compound content in pounds of volatile organic compounds per gallon of coating solids

Wo = Weight percent of volatile organic compounds (Wv - Ww - Wex)

Wv = Weight percent of total volatiles (100% - weight percent solids)

Ww = Weight percent of water

Wex = Weight percent of exempt solvent(s)

Dc = Density of coating, pounds per gallon, at 25°C

Vn = Volume percent of solids of the as applied coating

**SECTION D. Source Level Requirements****Fuel Restriction(s).****# 005 [25 Pa. Code §127.441]****Operating permit terms and conditions.**

The curing heater incorporated in Source 117 shall only be fired on natural gas or propane.

II. TESTING REQUIREMENTS.

No additional testing requirements exist except as provided in other sections of this permit including Section B (State Only General Requirements).

III. MONITORING REQUIREMENTS.**# 006 [25 Pa. Code §127.441]****Operating permit terms and conditions.**

Control Device C117 shall be equipped with instrumentation to continuously monitor the differential pressure across the control device.

IV. RECORDKEEPING REQUIREMENTS.**# 007 [25 Pa. Code §127.441]****Operating permit terms and conditions.**

The permittee shall maintain accurate and comprehensive records of the following:

- (1) The type(s) and amount(s) of surface coatings used in Source 117 each month.
- (2) The type(s) and amount(s) of solvents and thinners added to surface coatings used in Source 117 each month.
- (3) The type(s) and amount(s) of cleanup solvents used in Source 117 each month.
- (4) The type(s) and amount(s) of cleanup solvents shipped off site from Source 117 each month.
- (5) Calculations used to verify compliance with the volatile organic compound and volatile hazardous air pollutant emission limitations specified herein for Source 117 for each month.

All records generated pursuant to this condition shall be retained for a minimum of five (5) years and shall be made available to the Department upon request.

008 [25 Pa. Code §129.52]**Surface coating processes**

The permittee shall maintain daily records of:

- (1) The following parameters for each coating, thinner and other component used in Source 117, as supplied:
 - (a) The coating, thinner or component name and identification number.
 - (b) The volume used.
 - (c) The mix ratio.
 - (d) The density or specific gravity.
 - (e) The weight percent of total volatiles, water, solids and exempt solvents.
 - (f) The volume percent of solids for "miscellaneous metal parts & products/air-dried coatings" of subsection 10(e) of Table 1 of 25 Pa. Code Section 129.52.
- (2) The volatile organic compound content of each coating, thinner and other component used in Source 117, as supplied.
- (3) The volatile organic compound content of each coating used in Source 117, as applied coating.

All records generated pursuant to this condition shall be retained for a minimum of five (5) years and shall be made available to the Department upon request.

**SECTION D. Source Level Requirements****V. REPORTING REQUIREMENTS.****# 009 [25 Pa. Code §127.441]****Operating permit terms and conditions.**

The permittee shall submit reports on an annual basis of the following:

- (1) The type(s) and amount(s) of surface coatings used in Source 117 each month during the respective calendar year.
- (2) The type(s) and amount(s) of solvents and thinners used in Source 117 each month during the respective calendar year.
- (3) The type(s) and amount(s) of cleanup solvents used in Source 117 each month during the respective calendar year.
- (4) The type(s) and amount(s) of cleanup solvents shipped off site from Source 117 each month during the respective calendar year.
- (5) Calculations used to verify compliance with the volatile organic compound and volatile hazardous air pollutant emission limitations specified herein for Source 117 for each month during the respective calendar year.

The annual reports shall be submitted to the Department by no later than March 1 for the preceding calendar year.

VI. WORK PRACTICE REQUIREMENTS.**# 010 [25 Pa. Code §127.441]****Operating permit terms and conditions.**

All coatings used in Source 117 shall be applied using high volume low pressure (HVL) spray technology (or an application technique determined by the Department to have an equivalent transfer efficiency).

011 [25 Pa. Code §127.441]**Operating permit terms and conditions.**

All volatile organic compound-containing materials, volatile hazardous air pollutant-containing materials used in, or in association with, Source 117 shall be stored in closed containers when not in actual use. Spray lines, guns, etc. shall be cleaned by either flushing a solid liquid stream of solvent into an appropriate container or by soaking equipment in closed containers of liquid solvent. Cleaning solvents shall not be sprayed or flushed from a spray gun, nozzle or line directly into the air nor shall they be flushed into a container as an atomized spray. All used cleaning solvent and all solvent-wet rags or cloths shall be stored in closed containers when not in actual use and shall never be treated in any manner which would unnecessarily promote the evaporative loss of cleaning solvent to the atmosphere.

012 [25 Pa. Code §127.441]**Operating permit terms and conditions.**

The permittee shall keep on hand a sufficient quantity of spare overspray filters for Control Device C117 in order to be able to immediately replace any filters requiring replacement due to deterioration resulting from the routine operation of the Source 117 and Control Device C117.

VII. ADDITIONAL REQUIREMENTS.**# 013 [25 Pa. Code §127.441]****Operating permit terms and conditions.**

Source 117 is a surface coating and surface coating cleanup operation comprised of a 16'x 12'x 34' Grapek-Bates surface coating spray booth incorporating a 1.866 million Btu per hour, natural gas-fired curing heater. The particulate matter emissions from the surface coating spray booth shall be controlled by overspray filters.

**SECTION D. Source Level Requirements**

Source ID: 118

Source Name: POLYURETHANE FOAM PACKAGING OPERATION

Source Capacity/Throughput:

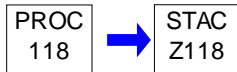
**I. RESTRICTIONS.**

No additional requirements exist except as provided in other sections of this permit including Section B (State Only General Requirements).

II. TESTING REQUIREMENTS.

No additional testing requirements exist except as provided in other sections of this permit including Section B (State Only General Requirements).

III. MONITORING REQUIREMENTS.

No additional monitoring requirements exist except as provided in other sections of this permit including Section B (State Only General Requirements).

IV. RECORDKEEPING REQUIREMENTS.**# 001 [25 Pa. Code §127.441]****Operating permit terms and conditions.**

The permittee shall maintain accurate and comprehensive records of the identity, the amount and the volatile organic compound content of each material used in Source 118 for each month. All records generated pursuant to this condition shall be retained for a minimum of five (5) years and shall be made available to the Department upon request.

V. REPORTING REQUIREMENTS.

No additional reporting requirements exist except as provided in other sections of this permit including Section B (State Only General Requirements).

VI. WORK PRACTICE REQUIREMENTS.

No additional work practice requirements exist except as provided in other sections of this permit including Section B (State Only General Requirements).

VII. ADDITIONAL REQUIREMENTS.**# 002 [25 Pa. Code §127.441]****Operating permit terms and conditions.**

Source 118 is a polyurethane foam packaging operation located in Plant 2.

**SECTION D. Source Level Requirements**

Source ID: 119

Source Name: PATTERN SHOP

Source Capacity/Throughput:

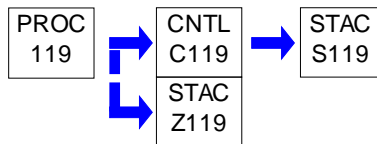
**I. RESTRICTIONS.****Emission Restriction(s).**

001 [25 Pa. Code §123.13]

Processes

The permittee shall not permit the emission of particulate matter into the outdoor atmosphere from Source 119 in such a manner that the concentration in the effluent gas from Control Device C119 exceeds 0.04 grains per dry standard cubic foot.

II. TESTING REQUIREMENTS.

No additional testing requirements exist except as provided in other sections of this permit including Section B (State Only General Requirements).

III. MONITORING REQUIREMENTS.

No additional monitoring requirements exist except as provided in other sections of this permit including Section B (State Only General Requirements).

IV. RECORDKEEPING REQUIREMENTS.

002 [25 Pa. Code §127.441]

Operating permit terms and conditions.

The permittee shall maintain accurate and comprehensive records of the identity, the amount and the volatile organic compound content of each epoxy resin used in Source 119 for each month. All records generated pursuant to this condition shall be retained for a minimum of five (5) years and shall be made available to the Department upon request.

V. REPORTING REQUIREMENTS.

No additional reporting requirements exist except as provided in other sections of this permit including Section B (State Only General Requirements).

VI. WORK PRACTICE REQUIREMENTS.

No additional work practice requirements exist except as provided in other sections of this permit including Section B (State Only General Requirements).

VII. ADDITIONAL REQUIREMENTS.

003 [25 Pa. Code §127.441]

Operating permit terms and conditions.

Source 119 is a pattern shop, located in Building 42 of Plant 1, that incorporates wood working equipment, the particulate matter emissions from which shall be controlled by a cyclone (Control Device C119).

**SECTION D. Source Level Requirements**

Source ID: 120

Source Name: DEGREASERS

Source Capacity/Throughput:

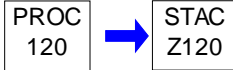
**I. RESTRICTIONS.**

No additional requirements exist except as provided in other sections of this permit including Section B (State Only General Requirements).

II. TESTING REQUIREMENTS.

No additional testing requirements exist except as provided in other sections of this permit including Section B (State Only General Requirements).

III. MONITORING REQUIREMENTS.

No additional monitoring requirements exist except as provided in other sections of this permit including Section B (State Only General Requirements).

IV. RECORDKEEPING REQUIREMENTS.**# 001 [25 Pa. Code §127.441]****Operating permit terms and conditions.**

The permittee shall maintain accurate and comprehensive records on a monthly basis of the identity, the amount and the volatile organic compound content of each degreasing solvent used in Source 120, as well as the amount and identity of spent degreasing solvent shipped off site. All records generated pursuant to this condition shall be retained for a minimum of five (5) years and shall be made available to the Department upon request.

002 [25 Pa. Code §129.63]**Degreasing operations**

The permittee shall maintain accurate and comprehensive records of the following:

- (1) The name and address of the solvent supplier.
- (2) The type of solvent including the product or vendor identification number.
- (3) The vapor pressure of the solvent measured in mm Hg at 20°C (68°F).

All such records shall be retained at least five (5) years and shall be made available to the Department upon request. An invoice, bill of sale, certificate that corresponds to a number of sales, Material Safety Data Sheet (MSDS), or other appropriate documentation acceptable to the Department may be used to comply with this section.

V. REPORTING REQUIREMENTS.

No additional reporting requirements exist except as provided in other sections of this permit including Section B (State Only General Requirements).

VI. WORK PRACTICE REQUIREMENTS.**# 003 [25 Pa. Code §129.63]****Degreasing operations**

The cold batch cleaning machines incorporated in Source 120 shall have a permanent, conspicuous label summarizing the operating requirements specified in condition #006 herein. In addition, the label shall also list the following discretionary good operating practices:

**SECTION D. Source Level Requirements**

- (1) Cleaned parts should be drained at least 15 seconds or until dripping ceases, whichever is longer. Parts having cavities or blind holes shall be tipped or rotated while the part is draining. During the draining, tipping or rotating, the parts should be positioned so that solvent drains directly back to the cold cleaning machine.
- (2) When a pump-agitated solvent bath is used, the agitator should be operated to produce a rolling motion of the solvent with no observable splashing of the solvent against the tank walls or the parts being cleaned.
- (3) Work area fans should be located and positioned so that they do not blow across the opening of the degreaser unit.

004 [25 Pa. Code §129.63]**Degreasing operations**

The cold batch cleaning machines incorporated in Source 120 shall be equipped with a cover(s) that shall be closed at all times except during the cleaning of parts or the addition or removal of solvent. A perforated drain with a diameter of not more than 6 inches shall constitute an acceptable cover.

005 [25 Pa. Code §129.63]**Degreasing operations**

Solvents with a vapor pressure of 1.0 millimeter of mercury (mm Hg) or greater, measured at 20°C (68°F), shall not be used in the cold batch cleaning machines incorporated in Source 120.

006 [25 Pa. Code §129.63]**Degreasing operations**

The cold batch cleaning machines incorporated in Source 120 shall be operated in accordance with the following procedures:

- (1) Waste solvent shall be collected and stored in closed containers. The closed containers may contain a device that allows pressure relief, but does not allow liquid solvent to drain from the container.
- (2) Flushing of parts using a flexible hose or other flushing device shall be performed only within the cold cleaning machine. The solvent spray shall be a solid fluid stream, not an atomized or shower spray.
- (3) Sponges, fabric, wood, leather, paper products and other absorbent materials may not be cleaned in the cold cleaning machine.
- (4) Air agitated solvent baths may not be used.
- (5) Spills during solvent transfer and use of the cold cleaning machine shall be cleaned up immediately.

VII. ADDITIONAL REQUIREMENTS.**# 007 [25 Pa. Code §127.441]****Operating permit terms and conditions.**

Source 120 is comprised of nine (9) remote reservoir cold batch cleaning machines.

**SECTION D. Source Level Requirements**

Source ID: 121

Source Name: LADLE TORCHES

Source Capacity/Throughput:

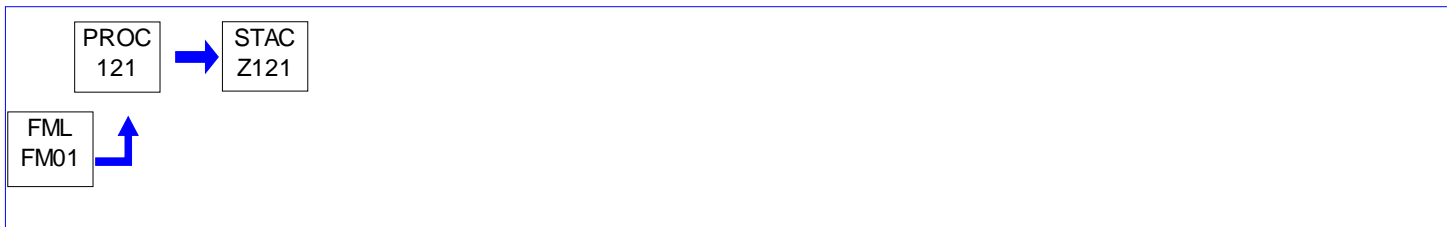
**I. RESTRICTIONS.**

No additional requirements exist except as provided in other sections of this permit including Section B (State Only General Requirements).

II. TESTING REQUIREMENTS.

No additional testing requirements exist except as provided in other sections of this permit including Section B (State Only General Requirements).

III. MONITORING REQUIREMENTS.

No additional monitoring requirements exist except as provided in other sections of this permit including Section B (State Only General Requirements).

IV. RECORDKEEPING REQUIREMENTS.

No additional record keeping requirements exist except as provided in other sections of this permit including Section B (State Only General Requirements).

V. REPORTING REQUIREMENTS.

No additional reporting requirements exist except as provided in other sections of this permit including Section B (State Only General Requirements).

VI. WORK PRACTICE REQUIREMENTS.

No additional work practice requirements exist except as provided in other sections of this permit including Section B (State Only General Requirements).

VII. ADDITIONAL REQUIREMENTS.**# 001 [25 Pa. Code §127.441]****Operating permit terms and conditions.**

Source 121 is comprised of eight (8) 1.0 million Btu per hour (each) natural gas-fired ladle torches.

**SECTION D. Source Level Requirements**

Source ID: 138

Source Name: ELECTRIC INDUCTION FURNACES

Source Capacity/Throughput:

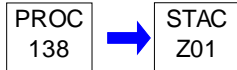
**I. RESTRICTIONS.****Throughput Restriction(s).****# 001 [25 Pa. Code §127.441]****Operating permit terms and conditions.**

(1) All scrap used in the induction furnaces incorporated in Source 138 shall be either shot-blasted foundry reverts or plate scrap conforming to a maximum 0.5% oil and/or dirt content purchase specification. Additionally, all scrap used in these furnaces shall first be processed through a scrap dryer.

(2) The induction furnaces incorporated in Source 138 can be used to produce ductile iron provided they are used in conjunction with a teapot ladle.

II. TESTING REQUIREMENTS.

No additional testing requirements exist except as provided in other sections of this permit including Section B (State Only General Requirements).

III. MONITORING REQUIREMENTS.

No additional monitoring requirements exist except as provided in other sections of this permit including Section B (State Only General Requirements).

IV. RECORDKEEPING REQUIREMENTS.**# 002 [25 Pa. Code §127.441]****Operating permit terms and conditions.**

The permittee shall maintain accurate and comprehensive records of the supplier certifications for #1 machinery cast and plate scrap conforming to a maximum 0.5% oil and/or dirt purchase specification and for shot-blasted (except for Nihard) foundry reverts that are delivered for use in the induction furnaces incorporated in Source 138. All records generated pursuant to this condition shall be retained for a minimum of five (5) years and shall be made available to the Department upon request.

003 [25 Pa. Code §127.441]**Operating permit terms and conditions.**

The permittee shall maintain such records as are necessary to demonstrate that the two (2) 2,400 pound per hour induction furnaces incorporated in Source 138 have not been operated simultaneously.

V. REPORTING REQUIREMENTS.

No additional reporting requirements exist except as provided in other sections of this permit including Section B (State Only General Requirements).

VI. WORK PRACTICE REQUIREMENTS.

No additional work practice requirements exist except as provided in other sections of this permit including Section B (State Only General Requirements).

**SECTION D. Source Level Requirements****VII. ADDITIONAL REQUIREMENTS.****# 004 [25 Pa. Code §127.441]****Operating permit terms and conditions.**

Source 138 incorporates the following induction furnaces:

- (1) three 4,000-pound (each) Inductotherm coreless induction furnaces.
- (2) two 2,400-pound (each) Inductotherm coreless induction furnaces.

005 [25 Pa. Code §127.441]**Operating permit terms and conditions.**

[Additional authority for this permit condition is derived from 25 Pa. Code Section 127.1 and 127.12]

The two 2,400 pound per hour induction furnaces incorporated in Source 138 currently share a common power supply. Only one of the furnaces shall be operated at any given time.

**SECTION D. Source Level Requirements**

Source ID: 139

Source Name: REFINER PLATE MOLDING OPERATION

Source Capacity/Throughput:

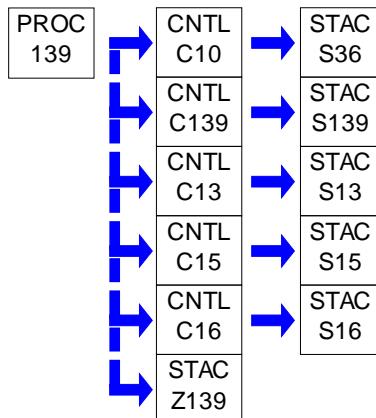
**I. RESTRICTIONS.****Emission Restriction(s).****# 001 [25 Pa. Code §123.13]****Processes**

The permittee shall not permit the emission of particulate matter into the outdoor atmosphere from Source 139 in such a manner that the concentration in the effluent gas from Control Device C139 exceeds 0.04 grains per dry standard cubic foot.

002 [25 Pa. Code §127.441]**Operating permit terms and conditions.**

[Additional authority for this permit condition is derived from the permittee volunteering to accept it as a restriction]

The total combined volatile organic compound emissions from Source 139, excluding the volatile organic compound emissions from the use of parting agents and from the Vulcan Engineering Co. thermal foundry sand reclamation system incorporated in Source 139, shall not exceed 38.29 tons in any 12 consecutive month period.

Compliance with this permit condition also ensures compliance with 25 Pa. Code Sections 127.1, 127.12 and 129.91 through 129.95.

003 [25 Pa. Code §127.441]**Operating permit terms and conditions.**

[Additional authority for this permit condition is derived from 25 Pa. Code Sections 127.1 and 127.12]

The particulate matter emissions (including particulate matter with an aerodynamic diameter of 10 microns or less also known as PM10) from Control Device C13 shall not at any time exceed 0.007 grains per dry standard cubic foot of collector exhaust, 1.94 pounds per hour and 8.49 tons in any 12 consecutive month period.

Compliance with this permit condition also ensures compliance with 25 Pa. Code Section 123.13.

004 [25 Pa. Code §127.441]**Operating permit terms and conditions.**

[Additional authority for this permit condition is derived from 25 Pa. Code Sections 127.1 and 127.12]

There shall be no visible air contaminant emissions from the exhausts of Control Devices C13, C15 and C16 except for water vapor or steam.

005 [25 Pa. Code §127.441]**Operating permit terms and conditions.**

[Additional authority for this permit condition is derived from 25 Pa. Code Sections 127.1 and 127.12]

**SECTION D. Source Level Requirements**

The fugitive particulate matter emissions (including particulate matter with an aerodynamic diameter of 10 microns or less also known as PM10) from the sand feed system vibratory feeder of the Vulcan Engineering Co. thermal foundry sand reclamation system incorporated in Source 139 shall not at any time exceed 0.18 pounds per hour and 0.79 tons in any 12 consecutive month period.

006 [25 Pa. Code §127.441]

Operating permit terms and conditions.

[Additional authority for this permit condition is derived from 25 Pa. Code Sections 127.1 and 127.12]

The particulate matter emissions (including particulate matter with an aerodynamic diameter of 10 microns or less also known as PM10) from Control Devices C15 and C16 shall not at any time exceed 0.01 grains per dry standard cubic foot of collector exhaust, 0.077 pounds per hour (both collectors combined) and 0.34 tons in any 12 consecutive month period (both collectors combined).

Compliance with this permit condition also ensures compliance with 25 Pa. Code Section 123.13.

007 [25 Pa. Code §127.441]

Operating permit terms and conditions.

[Additional authority for this permit condition is derived from 25 Pa. Code Sections 127.1 and 127.12]

The sulfur oxides, nitrogen oxides (NO_x, expressed as NO₂), volatile organic compound and carbon monoxide emissions from the Vulcan Engineering Co. thermal foundry sand reclamation system incorporated in Source 139 shall not at any time exceed 0.35 pounds, 3.1 pounds, 0.53 pounds and 0.59 pounds per hour, respectively, nor shall they exceed 1.53 tons, 13.59 tons, 2.33 tons and 2.58 tons, respectively, in any 12 consecutive month period.

008 [25 Pa. Code §127.441]

Operating permit terms and conditions.

[Additional authority for this permit condition is derived from 25 Pa. Code Sections 127.1 and 127.12]

The particulate matter emissions (including particulate matter with an aerodynamic diameter of 10 microns or less also known as PM10) from Control Device C10 shall not at any time exceed 0.02 grains per dry standard cubic foot of collector exhaust and 21 tons in any 12 consecutive month period.

Compliance with this permit condition also ensures compliance with 25 Pa. Code Section 123.13.

Fuel Restriction(s).

009 [25 Pa. Code §127.441]

Operating permit terms and conditions.

[Additional authority for this permit condition is derived from 25 Pa. Code Sections 127.1 and 127.12]

The Vulcan Engineering Co. thermal foundry sand reclamation system incorporated in Source 139 shall only be fired on natural gas.

Operation Hours Restriction(s).

010 [25 Pa. Code §127.441]

Operating permit terms and conditions.

[Additional authority for this permit condition is derived from 25 Pa. Code Section 127.1, 127.12 and 129.91 through 129.95]

The permittee may operate Source 139 up to 8,760 hours in any 12 consecutive month period.

Throughput Restriction(s).

011 [25 Pa. Code §127.441]

Operating permit terms and conditions.

[Additional authority for this permit condition is derived from 25 Pa code Sections 127.1, 127.12 and 129.91 through 129.95]

**SECTION D. Source Level Requirements**

The total amount of steel processed in Source 139 shall not exceed 14,000 tons in any 12 consecutive month period.

II. TESTING REQUIREMENTS.**# 012 [25 Pa. Code §127.441]****Operating permit terms and conditions.**

- (1) Within one (1) year from the date of issuance of the State Only operating permit (DEP Auth ID: 1451417), the permittee shall perform stack testing to determine the particulate matter emissions contained in the effluent gas from Control Device C10. All testing shall be performed while Source 139 is operating at its normal maximum rate of production.
- (2) Pursuant to 25 Pa. Code § 139.3, at least 90 calendar days prior to commencing a EPA reference method testing program, a test protocol shall be submitted to the Department for review and approval. One electronic copy shall be sent to the Northcentral Regional Office Air Quality Program at: ra-epncstacktesting@pa.gov and one electronic copy shall be sent to the PSIMS Administrator in Central Office at: ra-epstacktesting@pa.gov. The test protocol shall meet all applicable requirements specified in the most current version of the Department's Source Testing Manual.
- (3) Pursuant to 25 Pa. Code § 139.3, at least 15 calendar days prior to commencing an emission testing program, notification as to the date and time of testing shall be given to the Northcentral Regional Office. Notification shall also be sent to the Division of Source Testing and Monitoring. Notification shall not be made without prior receipt of a protocol acceptance letter from the Department.
- (4) If applicable, pursuant to 40 CFR § 60.8(a), 40 CFR § 61.13(f) and 40 CFR § 63.7(g), complete test reports shall be submitted to the Department no later than 60 calendar days after completion of the on-site testing portion of an EPA reference method test program.
- (5) Pursuant to 25 Pa. Code § 139.53(b) a complete test report shall include a summary of the emission results on the first page of the report indicating if each pollutant measured is within permitted limits and a statement of compliance or noncompliance with all applicable permit conditions. The summary results will include, at a minimum, the following information:
 - a. A statement that the owner or operator has reviewed the report from the emissions testing body and agrees with the findings.
 - b. Permit number(s) and condition(s) which are the basis for the evaluation.
 - c. Summary of results with respect to each applicable permit condition.
 - d. Statement of compliance or non-compliance with each applicable permit condition.
- (6) Pursuant to 25 Pa. Code § 139.3, all submittals shall meet all applicable requirements specified in the most current version of the Department's Source Testing Manual.
- (7) All testing shall be performed in accordance with the provisions of Chapter 139 of the Rules and Regulations of the Department of Environmental Protection.
- (8) Pursuant to 25 Pa. Code § § 139.53(a)(1) and 139.53(a)(3), electronic copies of all submittals, besides notifications, shall be sent to the Northcentral Regional Office Air Quality Program Manager, with deadlines verified. In addition, an electronic copy shall be sent to the PSIMS Administrator in Central Office. Northcentral Regional Office email can be send at: ra-epncstacktesting@pa.gov. Central office email can be send at: ra-epstacktesting@pa.gov.
- (9) The permittee shall insure all federal reporting requirements contained in the applicable subpart of 40 CFR are followed, including timelines more stringent than those contained herein. In the event of an inconsistency or any conflicting requirements between state and the federal, the most stringent provision, term, condition, method or rule shall be used by default.

**SECTION D. Source Level Requirements****III. MONITORING REQUIREMENTS.****# 013 [25 Pa. Code §127.441]****Operating permit terms and conditions.**

[Additional authority for this permit condition is derived from 25 Pa. Code Sections 127.1 and 127.12]

The Vulcan Engineering Co. thermal foundry sand reclamation system incorporated in Source 139 shall be equipped with instrumentation to continuously monitor and record the overbed temperature of the fluidized bed reclamation unit.

014 [25 Pa. Code §127.441]**Operating permit terms and conditions.**

[Additional authority for this permit condition is derived from 25 Pa. Code Sections 127.1 and 127.12]

Control Device C13 shall be equipped with instrumentation to monitor the collector temperature and the differential pressure across the collector on a continuous basis, as well as be equipped with high collector temperature and high collector differential pressure alarms.

015 [25 Pa. Code §127.441]**Operating permit terms and conditions.**

[Additional authority for this permit condition is derived from 25 Pa. Code Sections 127.1 and 127.12]

Control Devices C10, C15 and C16 shall each be equipped with instrumentation to monitor the differential pressure across the respective collector on a continuous basis.

IV. RECORDKEEPING REQUIREMENTS.**# 016 [25 Pa. Code §127.441]****Operating permit terms and conditions.**

This condition has been intentionally left blank by the Department at this time to prevent errors on conditions numbering in this permit issuance.

017 [25 Pa. Code §127.441]**Operating permit terms and conditions.**

The permittee shall maintain accurate and comprehensive records of the following:

- (1) The supporting calculations used to verify compliance with the 12 consecutive month volatile organic compound emission limitation of 38.29 tons in any 12 consecutive month period established for Source 139 for each month.
- (2) The supporting calculations used to verify compliance with the 12 consecutive month Particulate Matter emission limitation established herein for ID C10 associated with Source 139.
- (3) The supporting calculations used to verify compliance with the 12 consecutive month particulate matter emission limitation established in Conditions ##003, 005, 006, and 008 for Source 139 for each month.
- (4) The number of hours that Source 139 operated each month.
- (5) The amount of steel processed in Source 139 each month, expressed in tons to verify compliance with 12 consecutive month throughput limitation of 14,000 tons.

All records generated pursuant to this condition shall be retained for a minimum of five (5) years and shall be made available to the Department upon request.

018 [25 Pa. Code §127.441]**Operating permit terms and conditions.**

The permittee shall maintain accurate and comprehensive records of the following:

- (1) The supporting calculations used to verify compliance with the 12 consecutive month air contaminant emission limitations established herein for the Vulcan Engineering Co. thermal foundry sand reclamation system incorporated in Source 139 for each month.
- (2) The number of hours the Vulcan Engineering Co. thermal foundry sand reclamation system incorporated in Source 139 is operated each month.
- (3) All temperature records generated by the continuous fluidized bed reclamation unit overbed temperature monitoring and

**SECTION D. Source Level Requirements**

recording system associated with the Vulcan Engineering Co. thermal foundry sand reclamation system incorporated in Source 139.

All records generated pursuant to this condition shall be retained for a minimum of five (5) years and shall be made available to the Department upon request.

V. REPORTING REQUIREMENTS.**# 019 [25 Pa. Code §127.441]****Operating permit terms and conditions.**

The permittee shall submit semi-annual reports to the Department of the following:

- (1) The supporting calculations used to verify compliance with the 12 consecutive month volatile organic compound emission limitation established under Conditions #002 and #007 for Source 139 for each month during the previous 12 months.
- (2) The supporting calculations used to verify compliance with the 12 consecutive month particulate matter emission limitation established under Conditions ##003, 005, 006, and 008 for Source 139 for each month during the previous 12 months.
- (3) The number of hours that Source 139 operated each month during the previous 12 months.
- (4) The amount of steel processed in Source ID 139 to verify compliance with 12 consecutive month throughput limitation of 14,000 tons.

Semi-annual reports shall be submitted to the Department by September 1 for the preceding period January 1 to June 30 and March 1 for the preceding period July 1 to December 31.

020 [25 Pa. Code §127.441]**Operating permit terms and conditions.**

The permittee shall submit semi-annual reports to the Department of the following:

- (1) The supporting calculations used to verify compliance with the 12 consecutive month air contaminant emission limitations established herein for the Vulcan Engineering Co. thermal foundry sand reclamation system incorporated in Source 139 for each month during the previous 12 months.
- (2) The number of hours the Vulcan Engineering Co. thermal foundry sand reclamation system incorporated in Source 139 operated each month during the previous 12 months.

Semi-annual reports shall be submitted to the Department by September 1 for the preceding period January 1 to June 30 and March 1 for the preceding period July 1 to December 31.

VI. WORK PRACTICE REQUIREMENTS.**# 021 [25 Pa. Code §127.441]****Operating permit terms and conditions.**

A sufficient quantity of spare filter bags and cartridges for Control Devices C10, C139, C13, C15 and C16 shall be kept on hand at all times in order to immediately replace any worn or damaged filter bags or cartridges due to deterioration resulting from routine operation of Source 139 and Control Devices C10, C139, C13, C15 and C16.

022 [25 Pa. Code §127.441]**Operating permit terms and conditions.**

[Additional authority for this permit condition is derived from 25 Pa. Code Sections 127.1 and 127.12]

Dust shall only be removed from the dust collection hopper(s) of Control Device C13 via an enclosed system and only into enclosed containers. Additionally, no visible fugitive air contaminant emissions shall occur as a result of removing dust from the dust collection hopper(s) of this fabric collector.

**SECTION D. Source Level Requirements****# 023 [25 Pa. Code §127.441]****Operating permit terms and conditions.**

[Additional authority for this permit condition is derived from 25 Pa. Code Sections 127.1 and 127.12]

(1) The sand feed system surge hopper, fluidized bed reclamation unit, heat exchanger and sand cooler/classifier associated with the Vulcan Engineering Co. thermal foundry sand reclamation unit ((1)(t)) incorporated in Source 139 shall not at any time be exhausted or vented to the atmosphere other than through Control Device C13.

(2) The pneumatically-fed 150 ton bulk sand storage silo ((1)(u)) and the two 182 ton capacity pneumatically-fed sand storage silos ((1)(v)) incorporated in Source 139 shall not at any time be exhausted or vented to the atmosphere other than through Control Device C13.

(3) The three pneumatically-fed sand transport feed hoppers ((1)(w)) incorporated in Source 139 shall not at any time be exhausted or vented to the atmosphere other than through Control Devices C15 and C16.

024 [25 Pa. Code §127.441]**Operating permit terms and conditions.**

[Additional authority for this permit condition is derived from 25 Pa. Code Sections 127.1 and 127.12]

The compressed air supply for Control Device C13 shall be equipped with a refrigerated compressed air dryer.

025 [25 Pa. Code §127.441]**Operating permit terms and conditions.**

[Additional authority for this permit condition is derived from 25 Pa. Code Sections 127.1 and 127.12]

Control Devices C15 and C16 shall be supplied with clean and dry compressed air.

026 [25 Pa. Code §127.441]**Operating permit terms and conditions.**

[Additional authority for this permit condition is derived from 25 Pa. Code Sections 127.1 and 127.12]

The setpoint for the overbed temperature of the fluidized bed reclamation unit associated with the Vulcan Engineering Co. thermal foundry sand reclamation system incorporated in Source 139 shall be no lower than 1308 degrees Fahrenheit. Additionally, any time the actual overbed temperature falls below 1308 degrees Fahrenheit, the sand feed shall be halted and shall not re-commence until the overbed temperature is once again at or above 1308 degrees Fahrenheit.

VII. ADDITIONAL REQUIREMENTS.**# 027 [25 Pa. Code §127.441]****Operating permit terms and conditions.**

[Additional authority for this permit condition is derived from 25 Pa. Code Sections 127.1 and 127.12]

(1) Source 139 is a refiner plate molding line which incorporates the following sources:

Mold making operation comprised of:

- (a) A pneumatically-fed facing sand mixer bin, a bucket elevator and an electric sand heater.
- (b) A Palmer M-Series 300 pound per minute facing sand mixer.
- (c) A pneumatically-fed backing mixer sand bin and an electric sand heater.
- (d) A Castec CEL 1000 backing sand mixer.
- (e) A vibratory compaction and a sand strikeoff station.
- (f) A mold draw station.
- (g) A powder coating station.
- (h) An infra-red mold curing oven.
- (i) A mold closing station.
- (j) A mold weight placement station.

Pouring and cooling operation comprised of:

**SECTION D. Source Level Requirements**

- (k) Three (3) pouring conveyor lines.
- (l) Four (4) cooling lines.

Casting shake-out operation comprised of:

- (m) A vibratory shakeout conveyor.
- (n) A General Kinematics lump breaker.
- (o) A sand elevator.
- (p) A magnetic separator.

Sand reclamation operation comprised of:

- (q) A pneumatically-fed reclaimer sand bin.
- (r) A sand cooler-classifier.
- (s) A pneumatically-fed Rotoclaim mechanical sand reclaimer.
- (t) A Vulcan Engineering Co. 6.0 ton per hour thermal foundry sand reclamation system incorporating a fluidized bed reclamation unit, a sand feed system (incorporating an enclosed 10 ton pneumatically-fed surge hopper and a vibratory feeder), a sand-to-air heat exchanger, a sand cooler/classifier and a 15.3 million Btu per hour natural gas-fired burner.
- (u) A pneumatically-fed 150 ton bulk sand storage silo.
- (v) Two (2) 182 ton capacity pneumatically-fed sand storage silos.
- (w) Three (3) pneumatically-fed sand transport feed hoppers.
- (x) Two (2) pneumatically-fed 350 ton sand storage silos.
- (y) A pneumatically-fed 50 ton sand storage silo.
- (z) A Palmer magnetic separator.
- (aa) A Palmer bucket elevator.
- (bb) A rotary screen and a sand cooler/classifier.

(2) The air contaminant emissions from ((1)(a)) through ((1)(s)) of this condition shall be controlled by an American Air Filter Fabri-Pulse model B size 12-316-3464 fabric collector (Control Device C10).

(3) The air contaminant emissions from ((1)(x)) and ((1)(y)) of this condition shall be controlled by an Amerex model RV-8-36 bin vent collector (Control Device C139).

(4) The air contaminant emissions from ((1)(t)), ((1)(u)), ((1)(v)), ((1)(z)), ((1)(aa)) and ((1)(bb)) of this condition shall be controlled by a Wheelabrator model 144 series 6P size 3017 TA-SB Modular Extended Jet III fabric collector (Control Device C13).

(5) The air contaminant emissions from ((1)(w)) of this condition shall be controlled by two Torit model TBV-4 bin vent cartridge collectors (Control Devices C15 and C16). Two hoppers shall be controlled by Control Device C15 and the third hopper shall be controlled by Control Device C16.

028 [25 Pa. Code §127.441]

Operating permit terms and conditions.

- (1) The permittee shall use an emission factor of 5.47 pounds of volatile organic compounds per ton of metal poured to calculate the volatile organic compound emissions from Source 139, excluding the volatile organic compound emissions from the Vulcan Engineering Co. thermal foundry sand reclamation system incorporated in Source 139 and from the use of parting agents. The emission factor may be changed upon request by the permittee and written approval by the Department.
- (2) Within ten (10) days following the trial use of any resin(s) not currently used at the facility, the permittee shall provide written notification of the trial to the Department. At a minimum, the notification shall include the date(s) the trial was performed, the approximate amount of metal that was poured during the trial and the volatile organic compound emission factor of the resin(s) used (expressed in pounds of volatile organic compounds per ton of metal poured).
- (3) Should the permittee wish to use any resin(s) not currently used at the facility on a permanent basis which would increase the VOC emissions, the permittee shall receive prior written approval from the Department so the Department may evaluate the potential emission of volatile organic compounds from use of the new resin(s). The permittee shall provide the Department with all information, documentation, etc. the Department deems necessary to make a proper evaluation.
- (4) Should the permittee wish to permanently modify the current sand to resin mix ratio which causes an increase in VOC emissions or emission rate, the permittee shall receive prior written approval from the Department so the Department may

**SECTION D. Source Level Requirements**

evaluate the potential emission of volatile organic compounds from use of the new sand to resin mix ratio. The permittee shall provide the Department with all information, documentation, etc. the Department deems necessary to make a proper evaluation.

(5) Should the permittee use any resin(s) not currently used at the facility on a permanent basis - a change which is deemed by the permittee to cause no increase in VOC emissions or emission rate - the permittee shall provide written notification of the change to the Department within ten days after the decision to make the change. The permittee shall provide the Department with all information, documentation, etc. the Department deems necessary to make a proper evaluation.

(6) Should the permittee permanently modify the current sand to resin mix ratio - a modification which is deemed by the permittee to cause no increase in VOC emissions or emission rate - the permittee shall provide written notification of the modification to the Department within ten days after the decision to make the change. The permittee shall provide the Department with all information, documentation, etc. the Department deems necessary to make a proper evaluation.

**SECTION D. Source Level Requirements**

Source ID: 142

Source Name: FLOOR MOLDING (NO-BAKE) OPERATION

Source Capacity/Throughput:

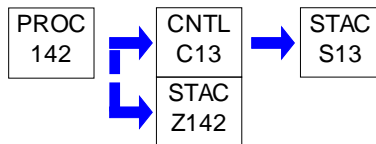
**I. RESTRICTIONS.****Emission Restriction(s).**

001 [25 Pa. Code §123.13]

Processes

The permittee shall not permit the emission of particulate matter into the outdoor atmosphere from Source 142 in such a manner that the concentration in the effluent gas from Control Device C13 exceeds 0.04 grains per dry standard cubic foot.

002 [25 Pa. Code §127.441]

Operating permit terms and conditions.

[Additional authority for this permit condition is derived from the permittee volunteering to accept it as a restriction]

The total combined volatile organic compounds emissions from Source 142, excluding the volatile organic compound emissions from the use of parting agents, shall not exceed 25.76 tons in any 12 consecutive month period.

Operation Hours Restriction(s).

003 [25 Pa. Code §127.441]

Operating permit terms and conditions.

[Additional authority for this permit condition is derived from 25 Pa. Code Sections 129.91 through 129.95]

The permittee may operate Source 142 up to 8,760 hours in any 12 consecutive month period.

Throughput Restriction(s).

004 [25 Pa. Code §127.441]

Operating permit terms and conditions.

[Additional authority for this permit condition is derived from 25 Pa. Code Sections 129.91 through 129.95]

The total amount of steel processed in Source 142 shall not exceed 14,000 tons in any 12 consecutive month period.

II. TESTING REQUIREMENTS.

No additional testing requirements exist except as provided in other sections of this permit including Section B (State Only General Requirements).

III. MONITORING REQUIREMENTS.

No additional monitoring requirements exist except as provided in other sections of this permit including Section B (State Only General Requirements).

IV. RECORDKEEPING REQUIREMENTS.

005 [25 Pa. Code §127.441]

Operating permit terms and conditions.

The permittee shall maintain accurate and comprehensive records of the following:

(1) The supporting calculations used to verify compliance with the 12 consecutive month volatile organic compound

**SECTION D. Source Level Requirements**

emission limitation established under condition #002 for Source 142 for each month.

(2) The amount of steel processed in Source 142 each month, expressed in tons.

(3) The number of hours that Source 142 is operated each month.

All records generated pursuant to this condition shall be retained for a minimum of five (5) years and shall be made available to the Department upon request.

V. REPORTING REQUIREMENTS.

006 [25 Pa. Code §127.441]

Operating permit terms and conditions.

The permittee shall submit semi-annual reports to the Department of the following:

(1) The supporting calculations used to verify compliance with the 12 consecutive month volatile organic compound emission limitation established under condition #002 for Source 142 for each month during the previous 12 months.

(2) The number of hours that Source 142 operated to verify compliance with the operational limitation for any 12 consecutive month period.

(3) The amount of steel processed in Source 142 in tons to verify compliance with the throughput limitation of 14,000 tons in any 12 consecutive month period.

Semi-annual reports shall be submitted to the Department by September 1 for the preceding period January 1 to June 30 and

March 1 for the preceding period July 1 to December 31.

VI. WORK PRACTICE REQUIREMENTS.

007 [25 Pa. Code §127.441]

Operating permit terms and conditions.

A sufficient quantity of spare filter bags for Control Device C13 shall be kept on hand at all times in order to immediately replace any worn or damaged filter bags due to deterioration resulting from routine operation of Source 142 and Control Device C13.

VII. ADDITIONAL REQUIREMENTS.

008 [25 Pa. Code §127.441]

Operating permit terms and conditions.

(1) The permittee shall use an emission factor of 3.68 pounds of volatile organic compounds per ton of metal poured to calculate the volatile organic compound emissions from Source 142, excluding the volatile organic compound emissions from the use of parting agents. The emission factor may be changed upon request by the permittee and written approval by the Department.

(2) Within ten (10) days following the trial use of any resin(s) not currently used at the facility, the permittee shall provide written notification of the trial to the Department. At a minimum, the notification shall include the date(s) the trial was performed, the approximate amount of metal that was poured during the trial and the volatile organic compound emission factor of the resin(s) used (expressed in pounds of volatile organic compounds per ton of metal poured).

(3) Should the permittee wish to use any resin(s) not currently used at the facility on a permanent basis which would increase the VOC emissions, the permittee shall receive prior written approval from the Department so the Department may evaluate the potential emission of volatile organic compounds from use of the new resin(s). The permittee shall provide the Department with all information, documentation, etc. the Department deems necessary to make a proper evaluation.

(4) Should the permittee wish to permanently modify the current sand to resin mix ratio which causes an increase in VOC emissions or emission rate, the permittee shall receive prior written approval from the Department so the Department may evaluate the potential emission of volatile organic compounds from use of the new sand to resin mix ratio. The permittee shall provide the Department with all information, documentation, etc. the Department deems necessary to make a proper evaluation.

(5) Should the permittee use any resin(s) not currently used at the facility on a permanent basis - a change which is deemed by the permittee to cause no increase in VOC emissions or emission rate - the permittee shall provide written notification of the change to the Department within ten days after the decision to make the change. The permittee shall provide the

**SECTION D. Source Level Requirements**

Department with all information, documentation, etc. the Department deems necessary to make a proper evaluation.
(6) Should the permittee permanently modify the current sand to resin mix ratio - a modification which is deemed by the permittee to cause no increase in VOC emissions or emission rate - the permittee shall provide written notification of the modification to the Department within ten days after the decision to make the change. The permittee shall provide the Department with all information, documentation, etc. the Department deems necessary to make a proper evaluation.

009 [25 Pa. Code §127.441]

Operating permit terms and conditions.

Source 142 is a no-bake floor molding operation incorporating the following sources:

- (1) two mixer sand bins.
- (2) one 300 pound per minute Fordath sand mixer.
- (3) one dense phase pneumatic transporter.

The particulate matter emissions from the Fordath sand mixer shall be controlled by a Wheelabrator model 144 series 6P size 3017 TA-SB Modular Extended Jet III fabric collector (Control Device C13).

**SECTION D. Source Level Requirements**

Source ID: 144

Source Name: GENERAL CASTINGS OPERATION

Source Capacity/Throughput:

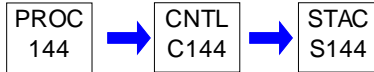
**I. RESTRICTIONS.****Emission Restriction(s).**

001 [25 Pa. Code §127.441]

Operating permit terms and conditions.

[Additional authority for this permit condition is also derived from 25 Pa. Code Sections 127.1 and 127.12]

The permittee shall not permit the emission of particulate matter into the outdoor atmosphere from Source 144 in such a manner that the concentration in the effluent gas from Control Device C144 exceeds 0.02 grains per dry standard cubic foot.

Operation Hours Restriction(s).

002 [25 Pa. Code §127.441]

Operating permit terms and conditions.

[Additional authority for this permit condition is derived from 25 Pa. Code Section 127.1 and 127.12]

The permittee shall not operate Source 144 more than 4,380 hours in any 12 consecutive month period.

II. TESTING REQUIREMENTS.

No additional testing requirements exist except as provided in other sections of this permit including Section B (State Only General Requirements).

III. MONITORING REQUIREMENTS.

003 [25 Pa. Code §127.441]

Operating permit terms and conditions.

Control Device C144 shall be equipped with instrumentation to monitor the differential pressure across the collector on a continuous basis.

IV. RECORDKEEPING REQUIREMENTS.

No additional record keeping requirements exist except as provided in other sections of this permit including Section B (State Only General Requirements).

V. REPORTING REQUIREMENTS.

No additional reporting requirements exist except as provided in other sections of this permit including Section B (State Only General Requirements).

VI. WORK PRACTICE REQUIREMENTS.

004 [25 Pa. Code §127.441]

Operating permit terms and conditions.

A sufficient quantity of spare filter bags for Control Device C144 shall be kept on hand at all times in order to immediately replace any worn or damaged filter bags due to deterioration resulting from routine operation of Source 144 and Control Device C144.

**SECTION D. Source Level Requirements****VII. ADDITIONAL REQUIREMENTS.****# 005 [25 Pa. Code §127.441]****Operating permit terms and conditions.**

Source 144 incorporates the following sources:

- (1) manual overhung grinder station
- (2) manual snagger station
- (3) air arc/weld station

The particulate matter emissions from Source 144 shall be controlled by an American Air Filter model B-12-216-3464 fabric collector (Control Device C144).

**SECTION D. Source Level Requirements**

Source ID: 145

Source Name: EMERGENCY GENERATOR ENGINES

Source Capacity/Throughput:

**I. RESTRICTIONS.****Emission Restriction(s).****# 001 [25 Pa. Code §123.13]****Processes**

The permittee shall not permit the emission of particulate matter into the outdoor atmosphere from the emergency generator engines incorporated in Source 145 in such a manner that the concentration in the effluent gas exceeds 0.04 grains per dry standard cubic foot.

002 [25 Pa. Code §123.21]**General**

The permittee shall not permit the emission of sulfur oxides (SO_x), expressed as SO₂, into the outdoor atmosphere from the emergency generator engines incorporated in Source 145 in such a manner that the concentration of the sulfur oxides in the effluent gas exceeds 500 parts per million, by volume, dry basis.

003 [40 CFR Part 60 Standards of Performance for New Stationary Sources §40 CFR 60.4233]**Subpart JJJJ - Standards of Performance for Stationary Spark Ignition Internal Combustion Engines****What emission standards must I meet if I am an owner or operator of a stationary SI internal combustion engine?**

[Additional authority for the permit condition is derived from 40 CFR Section 60.4231 and 40 CFR Part 1054.105]

(a) The air contaminant emissions from the 25.3 brake-horsepower engine of the 15 kw emergency generator Source 145 shall not exceed the following:

- (1) hydrocarbons and nitrogen oxides (HC + NO_x) – 12.1 grams per kilowatt-hour
- (2) carbon monoxide – 610 grams per kilowatt-hour

(b) The air contaminant emissions from the 97.9 brake-horsepower engine of the 72.5 kw emergency generator of Source 145 shall not exceed the following:

- (1) hydrocarbons and nitrogen oxides (HC + NO_x) – 13.4 grams per kilowatt-hour
- (2) carbon monoxide – 519 grams per kilowatt-hour

Operation Hours Restriction(s).**# 004 [25 Pa. Code §127.441]****Operating permit terms and conditions.**

[Additional authority for this permit condition is also derived from 25 Pa. Code Sections 129.91 through 129.95]

Each of the emergency generator engine incorporated in Source 145 shall not be operated more than 500 hours in any 12 consecutive month period.

005 [40 CFR Part 60 Standards of Performance for New Stationary Sources §40 CFR 60.4243]**Subpart JJJJ - Standards of Performance for Stationary Spark Ignition Internal Combustion Engines****What are my compliance requirements if I am an owner or operator of a stationary SI internal combustion engine?**

Engines of the emergency generators of Source 145 may be operated for the purpose of maintenance checks and

**SECTION D. Source Level Requirements**

readiness testing, provided that the tests are recommended by Federal, State or local government, the manufacturer, the vendor, or the insurance company associated with the engines of emergency generator. Maintenance checks and readiness testing of such units is limited to 100 hours per year. The permittee may petition the Department for approval of additional hours to be used for maintenance checks and readiness testing, but a petition is not required if the permittee maintains records indicating that Federal, State, or local standards require maintenance and testing of the engines of emergency generators of Source 145 beyond 100 hours per year. Engines of the emergency generators of Source 145 may operate up to 50 hours per year in nonemergency situations, but those 50 hours are counted towards the 100 hours per year provided for maintenance and testing. The 50 hours per year for non-emergency situations cannot be used for peak shaving or to generate income for a facility to supply power to an electric grid or otherwise supply power as part of a financial arrangement with another entity. Any operation of the engines of the emergency generators of Source 145, other than emergency operation, maintenance and testing, and operation in non-emergency situations for up to 50 hours per year, as permitted in this condition, is prohibited.

II. TESTING REQUIREMENTS.

No additional testing requirements exist except as provided in other sections of this permit including Section B (State Only General Requirements).

III. MONITORING REQUIREMENTS.

**# 006 [40 CFR Part 60 Standards of Performance for New Stationary Sources §40 CFR 60.4237]
Subpart JJJJ - Standards of Performance for Stationary Spark Ignition Internal Combustion Engines
What are the monitoring requirements if I am an owner or operator of an emergency stationary SI internal combustion engine?**

The emergency generator engines of Source 145 shall each be equipped with a non-resettable hour meter.

IV. RECORDKEEPING REQUIREMENTS.

**# 007 [25 Pa. Code §127.441]
Operating permit terms and conditions.**

The permittee shall maintain accurate and comprehensive records of the total number of hours that each emergency generator engine incorporated in Source 145 is operated each month.

All records generated pursuant to this condition shall be retained for a minimum of five (5) years and shall be made available to the Department upon request.

**# 008 [40 CFR Part 60 Standards of Performance for New Stationary Sources §40 CFR 60.4245]
Subpart JJJJ - Standards of Performance for Stationary Spark Ignition Internal Combustion Engines
What are my notification, reporting, and recordkeeping requirements if I am an owner or operator of a stationary SI internal combustion engine?**

[Additional authority for the permit condition is derived from 40 CFR Section 60.4243]

The permittee shall maintain accurate and comprehensive records of maintenance conducted on the engines of the emergency generators of Source 145.

**# 009 [40 CFR Part 60 Standards of Performance for New Stationary Sources §40 CFR 60.4245]
Subpart JJJJ - Standards of Performance for Stationary Spark Ignition Internal Combustion Engines
What are my notification, reporting, and recordkeeping requirements if I am an owner or operator of a stationary SI internal combustion engine?**

The permittee shall keep monthly records of the hours of operation for each of the emergency generator engine of Source 145 that is recorded through the nonresettable hour meter. The permittee shall document how many hours are spent for emergency operation, including what classified the operation as emergency and how many hours are spent for non-emergency operation.

**SECTION D. Source Level Requirements**

All records generated pursuant to this condition shall be retained for a minimum of five (5) years and shall be made available to the Department upon request.

V. REPORTING REQUIREMENTS.**# 010 [25 Pa. Code §127.441]****Operating permit terms and conditions.**

The permittee shall submit annual reports to the Department of the total number of hours each emergency generator engine incorporated in Source 145 is operated each month.

The annual reports shall be submitted to the Department by no later than March 1 for the immediately-preceding January 1 through December 31 period.

011 [25 Pa. Code §127.441]**Operating permit terms and conditions.**

The submission of all reports required by Subpart JJJJ of the federal Standards of Performance for Stationary Spark Ignition Internal Combustion Engines, or required by any other applicable section specified in the federal Standards of Performance or the National Emission Standards for Hazardous Air Pollutants, must be made to both the Department of Environmental Protection and electronically to the Environmental Protection Agency. The electronic reports must be submitted using the subpart specific reporting form in the Compliance and Emissions Data Reporting Interface (CEDRI) that is accessed through EPA's Central Data Exchange (CDX) (www.epa.gov/cdx). However, if the reporting form specific to this subpart is not available in CEDRI at the time that the report is due, the written report must be submitted to the EPA e-mail address and Administrator postal address listed below.

EPA Region 3, Air and Radiation Division,
Permits Branch (3AD10)
Four Penn Center, 1600 John F. Kennedy Boulevard,
Philadelphia, Pennsylvania 19103-2852

The submission of all other requests, applications submittals and other communications required by Subpart JJJJ of the federal Standards of Performance for Stationary Spark Ignition Internal Combustion Engines, 40 CFR Sections 60.4230 through 60.4248, or required by any other applicable section specified in the federal Standards of Performance or the National Emission Standards for Hazardous Air Pollutants, must be made to both the Department of Environmental Protection and the Environmental Protection Agency. The copies may be sent to:

R3_Air_Apps_and_Notices@epa.gov

And

Pennsylvania Department of Environmental Protection
Air Quality Program Manager
208 W. Third Street, Suite 101
Williamsport, PA 17701

VI. WORK PRACTICE REQUIREMENTS.**# 012 [40 CFR Part 60 Standards of Performance for New Stationary Sources §40 CFR 60.4234]****Subpart JJJJ - Standards of Performance for Stationary Spark Ignition Internal Combustion Engines****How long must I meet the emission standards if I am an owner or operator of a stationary SI internal combustion engine?**

The permittee shall operate and maintain the engines of emergency generator engines of Source 145 such that compliance with the emission limitations is maintained over the entire life of the engines of the emergency generators.

**SECTION D. Source Level Requirements****# 013 [40 CFR Part 60 Standards of Performance for New Stationary Sources §40 CFR 60.4243]****Subpart JJJJ - Standards of Performance for Stationary Spark Ignition Internal Combustion Engines****What are my compliance requirements if I am an owner or operator of a stationary SI internal combustion engine?**

The permittee shall operate and maintain the engines of the emergency generators of Source 145 according to the manufacturer's emission-related written instructions. If the permittee adjusts the engines settings according to and consistent with the manufacturer's instructions, the engines of the emergency generators will not be considered out of compliance.

014 [40 CFR Part 60 Standards of Performance for New Stationary Sources §40 CFR 60.4243]**Subpart JJJJ - Standards of Performance for Stationary Spark Ignition Internal Combustion Engines****What are my compliance requirements if I am an owner or operator of a stationary SI internal combustion engine?**

The permittee shall operate and maintain the engines of the emergency generators of Source 145 such that compliance with the emission limitations specified in Source 145 is maintained over the entire life of each engine.

VII. ADDITIONAL REQUIREMENTS.**# 015 [25 Pa. Code §127.441]****Operating permit terms and conditions.**

Source 145 incorporates the following emergency generator engines:

- (1) one 15 kW Kohler model 15REYG emergency generator powered by a 25.3 bhp propane fired engine.
- (2) one 60 kW Kohler model KG60 emergency generator powered by a 97.9 bhp natural gas-fired engine.

016 [40 CFR Part 60 Standards of Performance for New Stationary Sources §40 CFR 60.4230]**Subpart JJJJ - Standards of Performance for Stationary Spark Ignition Internal Combustion Engines****Am I subject to this subpart?**

Engines of the emergency generators of Source 145 are subject to Subpart JJJJ of the federal Standards of Performance for Stationary Spark Ignition Internal Combustion Engines. The permittee shall comply with all applicable requirements specified in 40 CFR Sections 60.4230 through 60.4248.

017 [40 CFR Part 63 NESHAPS for Source Categories §40 CFR 63.6585]**Subpart ZZZZ - National Emissions Standards for Hazardous Air Pollutants for Stationary Reciprocating Internal Combustion Engines****Am I subject to this subpart?**

The emergency generator engines of Source 145 are subject to Subpart ZZZZ of the National Emission Standards for Hazardous Air Pollutants for Stationary Reciprocating Internal Combustion Engines. The permittee shall comply with all applicable requirements specified in 40 CFR Sections 63.6580 through 63.6675. Conformance with this Condition is demonstrated by complying with the requirements of 40 CFR Part 60, Subpart JJJJ requirements.

**SECTION D. Source Level Requirements**

Source ID: 146

Source Name: ABOVEGROUND STORAGE TANKS

Source Capacity/Throughput:

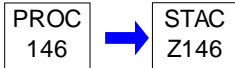
**I. RESTRICTIONS.****Emission Restriction(s).**

001 [25 Pa. Code §129.57]

Storage tanks less than or equal to 40,000 gallons capacity containing VOCs

The permittee shall not store any liquid containing volatile organic compounds with a vapor pressure greater than 1.5 psi (10.5 kilopascals) under actual storage conditions in the storage tanks incorporated in Source 146.

II. TESTING REQUIREMENTS.

No additional testing requirements exist except as provided in other sections of this permit including Section B (State Only General Requirements).

III. MONITORING REQUIREMENTS.

No additional monitoring requirements exist except as provided in other sections of this permit including Section B (State Only General Requirements).

IV. RECORDKEEPING REQUIREMENTS.

002 [25 Pa. Code §127.441]

Operating permit terms and conditions.

The permittee shall maintain accurate and comprehensive records of the vapor pressures of the binders stored in the storage tanks incorporated in Source 146. All records generated pursuant to this condition shall be retained for a minimum of five (5) years and shall be made available to the Department upon request.

V. REPORTING REQUIREMENTS.

No additional reporting requirements exist except as provided in other sections of this permit including Section B (State Only General Requirements).

VI. WORK PRACTICE REQUIREMENTS.

No additional work practice requirements exist except as provided in other sections of this permit including Section B (State Only General Requirements).

VII. ADDITIONAL REQUIREMENTS.

003 [25 Pa. Code §127.441]

Operating permit terms and conditions.

Source 146 incorporates two 6,650 gallon aboveground binder storage tanks.

**SECTION D. Source Level Requirements**

Source ID: P153

Source Name: PLATE FINISHING OPERATIONS

Source Capacity/Throughput:

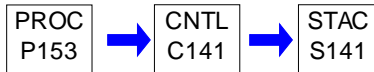
**I. RESTRICTIONS.****Emission Restriction(s).****# 001 [25 Pa. Code §127.441]****Operating permit terms and conditions.**

[Additional authority for this permit condition is derived from 25 Pa. Code Sections 127.1 and 127.12]

The concentration of particulate matter, including particulate matter having an aerodynamic diameter equal to or less than 10 micrometers, in the exhaust of Control Device C141 shall not exceed 0.02 grains per dry standard cubic foot of effluent gas volume at any time.

II. TESTING REQUIREMENTS.**# 002 [25 Pa. Code §127.441]****Operating permit terms and conditions.**

(1) Within one (1) year from the date of issuance of the State Only operating permit (DEP Auth ID: 1451417), the permittee shall perform stack testing to determine the particulate matter emissions contained in the effluent gas from Control Device C141. All testing shall be performed while Source 153 is operating at its normal maximum rate of production.

(2) Pursuant to 25 Pa. Code § 139.3, at least 90 calendar days prior to commencing a EPA reference method testing program, a test protocol shall be submitted to the Department for review and approval. One electronic copy shall be sent to the Northcentral Regional Office Air Quality Program at: ra-epncstacktesting@pa.gov and one electronic copy shall be sent to the PSIMS Administrator in Central Office at: ra-epstacktesting@pa.gov. The test protocol shall meet all applicable requirements specified in the most current version of the Department's Source Testing Manual.

(3) Pursuant to 25 Pa. Code § 139.3, at least 15 calendar days prior to commencing an emission testing program, notification as to the date and time of testing shall be given to the Northcentral Regional Office. Notification shall also be sent to the Division of Source Testing and Monitoring. Notification shall not be made without prior receipt of a protocol acceptance letter from the Department.

(4) If applicable, pursuant to 40 CFR § 60.8(a), 40 CFR § 61.13(f) and 40 CFR § 63.7(g), complete test reports shall be submitted to the Department no later than 60 calendar days after completion of the on-site testing portion of an EPA reference method test program.

(5) Pursuant to 25 Pa. Code § 139.53(b) a complete test report shall include a summary of the emission results on the first page of the report indicating if each pollutant measured is within permitted limits and a statement of compliance or noncompliance with all applicable permit conditions. The summary results will include, at a minimum, the following information:

- a. A statement that the owner or operator has reviewed the report from the emissions testing body and agrees with the findings.
- b. Permit number(s) and condition(s) which are the basis for the evaluation.
- c. Summary of results with respect to each applicable permit condition.
- d. Statement of compliance or non-compliance with each applicable permit condition.

(6) Pursuant to 25 Pa. Code § 139.3, all submittals shall meet all applicable requirements specified in the most current version of the Department's Source Testing Manual.

(7) All testing shall be performed in accordance with the provisions of Chapter 139 of the Rules and Regulations of the

**SECTION D. Source Level Requirements**

Department of Environmental Protection.

(8) Pursuant to 25 Pa. Code §§ 139.53(a)(1) and 139.53(a)(3), electronic copies of all submittals, besides notifications, shall be sent to the Northcentral Regional Office Air Quality Program Manager, with deadlines verified. In addition, an electronic copy shall be sent to the PSIMS Administrator in Central Office. Northcentral Regional Office email can be send at: ra-epncstacktesting@pa.gov. Central office email can be send at: ra-epstacktesting@pa.gov.

(9) The permittee shall insure all federal reporting requirements contained in the applicable subpart of 40 CFR are followed, including timelines more stringent than those contained herein. In the event of an inconsistency or any conflicting requirements between state and the federal, the most stringent provision, term, condition, method or rule shall be used by default.

III. MONITORING REQUIREMENTS.

003 [25 Pa. Code §127.441]

Operating permit terms and conditions.

[Additional authority for this permit condition is derived from 25 Pa. Code Sections 127.1 and 127.12]

Control Device C141 shall be equipped with instrumentation to monitor the pressure differential across the collector on a continuous basis.

IV. RECORDKEEPING REQUIREMENTS.

No additional record keeping requirements exist except as provided in other sections of this permit including Section B (State Only General Requirements).

V. REPORTING REQUIREMENTS.

No additional reporting requirements exist except as provided in other sections of this permit including Section B (State Only General Requirements).

VI. WORK PRACTICE REQUIREMENTS.

004 [25 Pa. Code §127.441]

Operating permit terms and conditions.

[Additional authority for this permit condition is derived from 25 Pa. Code Sections 127.1 and 127.12]

The air compressor supplying compressed air to Control Device C141 shall be equipped with an air dryer and oil trap.

005 [25 Pa. Code §127.441]

Operating permit terms and conditions.

[Additional authority for this permit condition is derived from 25 Pa. Code Sections 127.1 and 127.12]

A sufficient quantity of spare filter bags for Control Device C141 shall be kept on hand at all times in order to immediately replace any worn or damaged filter bags due to deterioration resulting from routine operation of Source P153 and Control Device C141.

VII. ADDITIONAL REQUIREMENTS.

006 [25 Pa. Code §127.441]

Operating permit terms and conditions.

Source P153 incorporates the following sources:

- (1) one Disa Goff Model PTM 6-120 shot blasting system
- (2) four plasma arc cutting/welding stations
- (3) one manual grinding/welding station

**SECTION D. Source Level Requirements**

(4) one belly grinder station

The particulate matter emissions from Source P153 shall be controlled by a Johnson-March Corporation Model STH-10-35 fabric collector (Control Device C141).

**SECTION D. Source Level Requirements**

Source ID: P154

Source Name: R&D OPERATION

Source Capacity/Throughput:

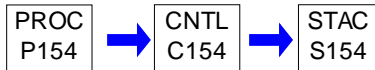
**I. RESTRICTIONS.****Emission Restriction(s).**

001 [25 Pa. Code §123.13]

Processes

The permittee shall not permit the emission of particulate matter into the outdoor atmosphere from Source P154 in such a manner that the concentration in the effluent gas from Control Device C154 exceeds 0.04 grains per dry standard cubic foot.

Operation Hours Restriction(s).

002 [25 Pa. Code §127.441]

Operating permit terms and conditions.

Source P154 shall not be operated more than 1,500 hours in any 12 consecutive month period.

II. TESTING REQUIREMENTS.

No additional testing requirements exist except as provided in other sections of this permit including Section B (State Only General Requirements).

III. MONITORING REQUIREMENTS.

003 [25 Pa. Code §127.441]

Operating permit terms and conditions.

Control Device C154 shall be equipped with instrumentation to monitor the pressure differential across the collector on a continuous basis.

IV. RECORDKEEPING REQUIREMENTS.

004 [25 Pa. Code §127.441]

Operating permit terms and conditions.

The permittee shall maintain accurate and comprehensive records of the total number of hours that Source P154 is operated each month. All records generated pursuant to this condition shall be retained for a minimum of five (5) years and shall be made available to the Department upon request.

V. REPORTING REQUIREMENTS.

005 [25 Pa. Code §127.441]

Operating permit terms and conditions.

The permittee shall submit annual reports to the Department of the total number of hours Source P154 is operated each month. The annual reports shall be submitted to the Department by no later than March 1 for the immediately-preceding January 1 through December 31 period.

VI. WORK PRACTICE REQUIREMENTS.

006 [25 Pa. Code §127.441]

Operating permit terms and conditions.

A sufficient quantity of spare filter bags for Control Device C154 shall be kept on hand at all times in order to immediately replace any worn or damaged filter bags due to deterioration resulting from routine operation of Source P154 and Control Device C154.

**SECTION D. Source Level Requirements****# 007 [25 Pa. Code §127.441]****Operating permit terms and conditions.**

The air compressor supplying compressed air to Control Device C154 shall be equipped with an air dryer and oil trap.

VII. ADDITIONAL REQUIREMENTS.**# 008 [25 Pa. Code §127.441]****Operating permit terms and conditions.**

Source P154 is a research and development (R&D) operation comprised of an Andritz model 43126 HS hammermill and an Andritz 5" model 501-G Ace pellet mill, the particulate matter emissions from which shall be controlled by a Max Process model 72AVR39 Style III fabric collector (Control Device C154).



SECTION E. Source Group Restrictions.



SECTION F. Alternative Operation Requirements.

No Alternative Operations exist for this State Only facility.



SECTION G. Emission Restriction Summary.

No emission restrictions listed in this section of the permit.



SECTION H. Miscellaneous.

The following air contaminant sources are considered to be of minor significance to the Department and have been determined to be exempt from permit requirements. However, this determination does not exempt the sources from compliance with all applicable air quality regulations specified in 25 Pa. Code Chapters 121-145:

- (1) Two 100-gallon (each) above ground propane storage tanks.
- (2) One wash down unit and associated natural gas-fired evaporator unit (heat input < 2.5 MMBtu/hr).
- (3) Heat treating operation.
- (4) One 2,400 pound induction furnace.



***** End of Report *****
